



Fall Protection

3M™ DBI-SALA® Confined Space Solutions

Get in easily.  
Get out safely.

# Confined Space. Unique challenges.

No two worksites are the same, but many of them have one thing in common: the presence of confined spaces. So how do you know if your worksite has one?

According to OSHA, confined spaces meet all of the following criteria:

- ▶ Large enough and so configured that an employee can bodily enter and perform assigned work
- ▶ Limited or restricted means for entry or exit
- ▶ Not designed for continuous employee occupancy

Some confined spaces require permits if there is a chance of serious health or safety concerns, such as engulfment, entrapment, asphyxiation or atmospheric hazards. For permit-required confined spaces where the worker enters to a depth of 5 ft. (1.5m) or greater, a mechanical means of retrieval is required and all entrants must use a full body harness. This rule applies to permit required confined spaces that cannot be declassified.

## Augment your expectations.

The 3M Fall Protection Configurator App is here. Use augmented reality to configure and visualize 3M Confined Space solutions directly in your work environment, right from your mobile device.



Contact 3M for more information, or to schedule a site assessment.

Learn more at [3M.com/ConfinedSpace](https://www.3m.com/ConfinedSpace).

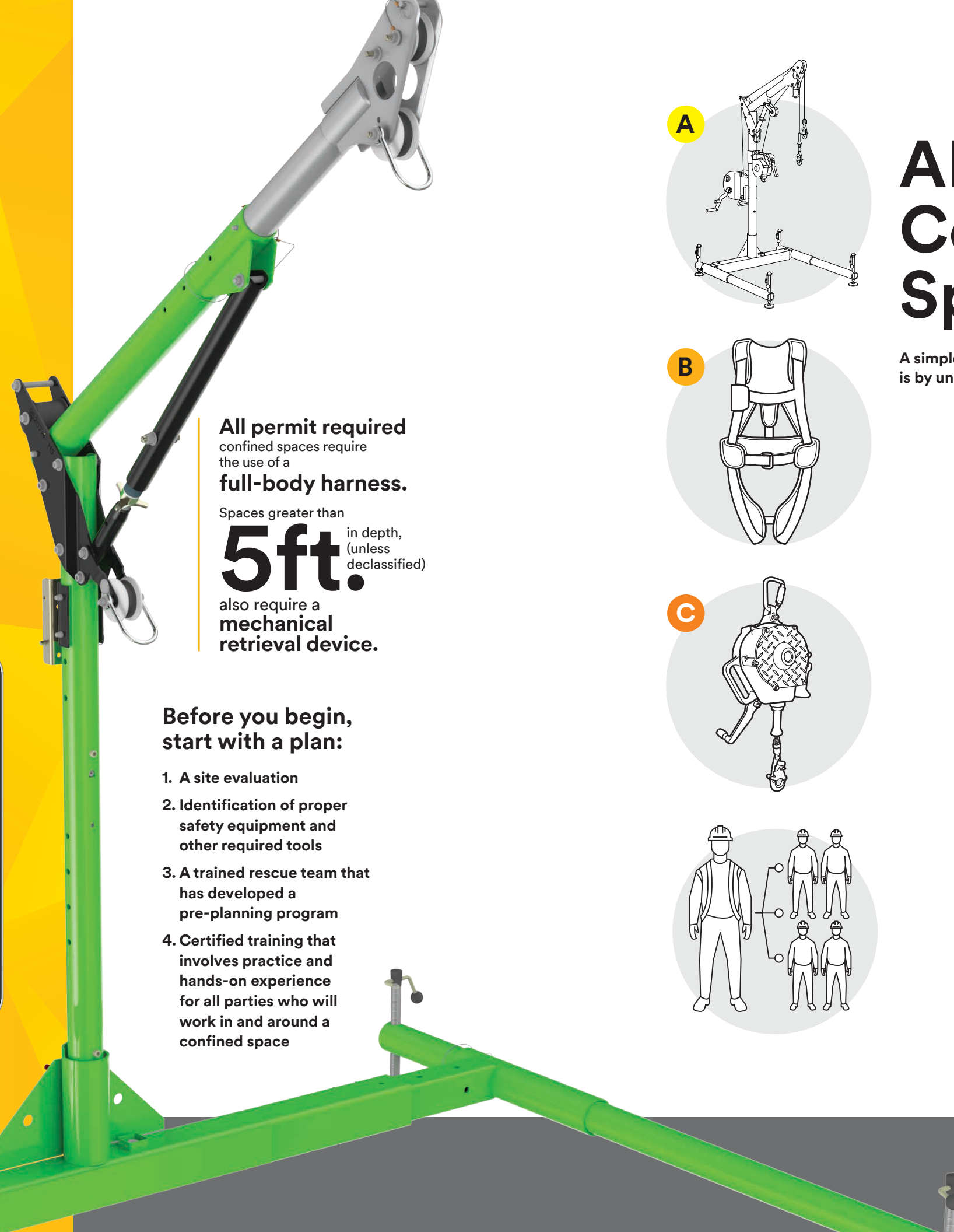

All permit required confined spaces require the use of a **full-body harness.**

Spaces greater than **5ft.** in depth, (unless declassified) also require a **mechanical retrieval device.**

## Before you begin, start with a plan:

1. A site evaluation
2. Identification of proper safety equipment and other required tools
3. A trained rescue team that has developed a pre-planning program
4. Certified training that involves practice and hands-on experience for all parties who will work in and around a confined space

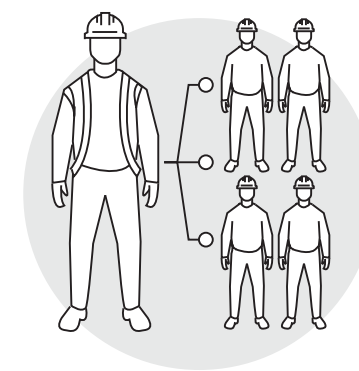
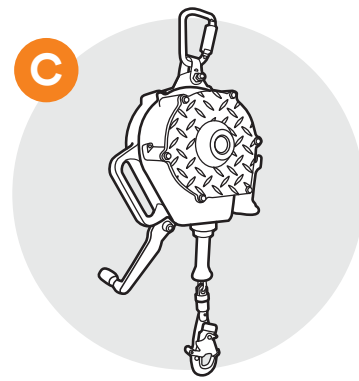
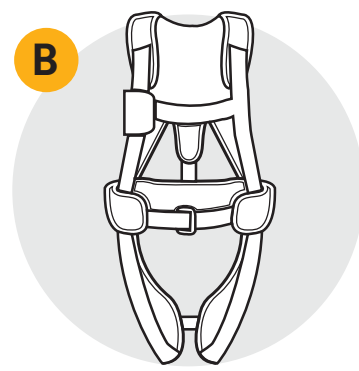
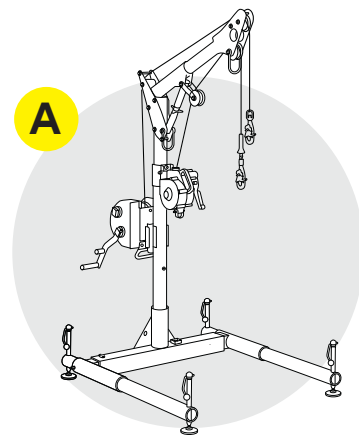

# ABC's of Confined Spaces

A simple way to think about confined space solutions is by understanding the ABC's of Confined Spaces:

- A Anchors**  
Davit systems, tripods and portable fall arrest posts are solutions where the worker's fall protection connector will be attached and is the main source of retrieval for the attendee. **Pgs. 6-23**
- B Body Support**  
Harnesses and work seats are two types of solutions that are designed to support the weight of the worker's body. **Pgs. 26-27**
- C Connectors**  
Winches and retrieval SRL's are the most common type of connector for confined spaces. **Pgs. 28-31**

## Compatibility

See our chart for davit arm and base compatibility. (Accurate as of printing. See [go.3m.com/ConfinedSpaceCompatibilityChart](https://go.3m.com/ConfinedSpaceCompatibilityChart) for most up-to-date information.) **Pgs. 24-25**

## Education

Confined space training courses delivered in person or online can provide required knowledge about hazards and best practices. **Pg. 32**

# Equipment you can trust. Expertise you can count on.

- Complete solution provider:**  
 From personal protective equipment to davit arm systems, 3M is a one-stop shop for all of your confined space safety solution needs.
- Trusted reputation:**  
 With over 60 years of experience, 3M™ DBI-SALA® Fall Protection has withstood the test of time and gained the trust of millions of workers around the world.
- Quality first:**  
 3M's state-of-the-art manufacturing facilities are used to design, innovate, test, and produce safe and compliant solutions.
- Versatility:**  
 We design solutions that are lightweight and modular to help ensure portability and meet the evolving needs of your worksite.



## Design considerations for confined space systems

### 1 Do you need a vertical or horizontal system?

#### Vertical Entry

Consider vertical entry solutions if accessing the top of a tank, an underground utility vault, manhole, shaft, duct, pit or degreaser.



#### Horizontal Entry

Consider horizontal entry solutions if accessing the side of a boiler, tunnel, duct keel, void space, ballast or oil tank.

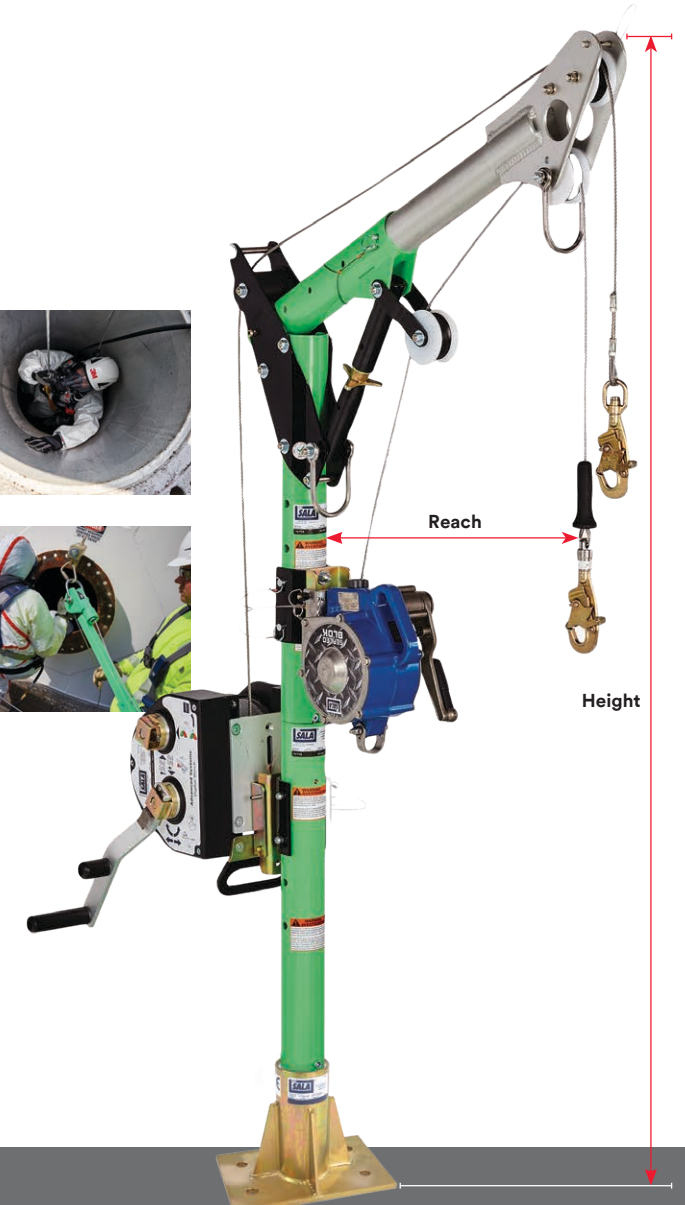

### 2 If choosing a vertical entry system, what reach and height are required?

Determine reach to the center of the entry point while considering overhead clearance limitations.

### 3 What number of workers are entering the space?

### 4 What type of system meets the needs of your application?

#### Permanent

Designed to be fastened to an existing structure to support the required loads. Typically intended to remain in one place for an extended period of time.

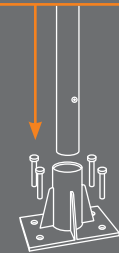

#### Freestanding

Does not require fastening or counterweight to support the required loads. Uses the system geometry to self-support.

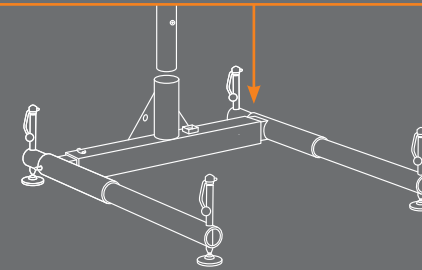

#### Counterweighted

Utilizes counterweight or ballast to support the required loads.

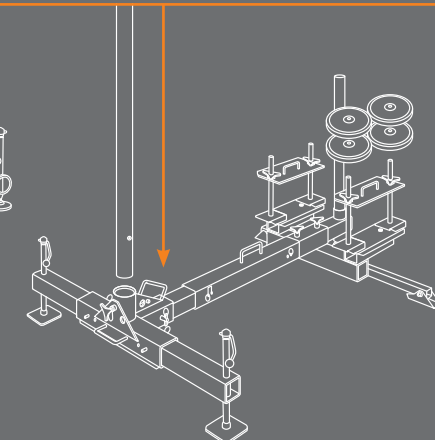

#### Integrated

Designed to integrate with an existing structure or piece of equipment to support the required loads.

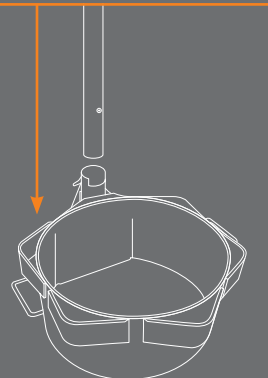

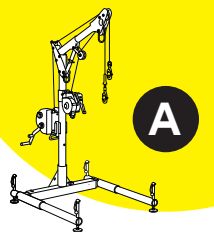

# 3M™ DBI-SALA®

## Davit Arm System Components

Variable offset davits are designed for use where multiple offset masts are required. The variable offset masts may be equipped with front mounted and/or back mounted winches or Self-Retracting Lifelines (SRLs) and feature an anchor point rated up to 5,000 lbs. (22 kN). For applications with overhead clearance restrictions, the adjustable height of the variable offset masts can eliminate the need for custom length masts and mast extensions. Quick-connect/release pins allow for fast and easy setup, dismantle and transport.

### 1 Winch

Davits can be equipped with both primary and secondary (back-up) mechanical devices for added flexibility. Retrieval winches can be used in conjunction with a retrieval SRL or fall protection system to raise and lower personnel and equipment.

### 2 Quick-mounting brackets

Simple detent-style winch mounting brackets make installation fast and efficient. (See page 16 for options.)

### 3 Retrieval SRL

Retrieval SRLs offer fall protection as well as emergency retrieval for non-entry rescue.

### 4 Lower mast extensions

Allow the user to adjust the overall anchorage height of the system.

### 5 Base options

Several portable and fixed base options are available for complete versatility.



### 6 Variable offset mast

Adjustable length of davit ensures lifelines are always centered over confined space.

### 7 Built-in pulleys

Route lifelines of two mechanical devices for smooth, efficient operation.

### 8 Fall arrest anchorage

Up to a 5,000 lb. (22 kN) rated anchor point for fall arrest device.

### 9 Adjustable height

Eliminates the need for custom length masts and extensions.



## Davit Systems

### Complete Davit Systems

Turnkey davit arm systems come with all the davit components, connecting devices, and accessories needed to get the job done.

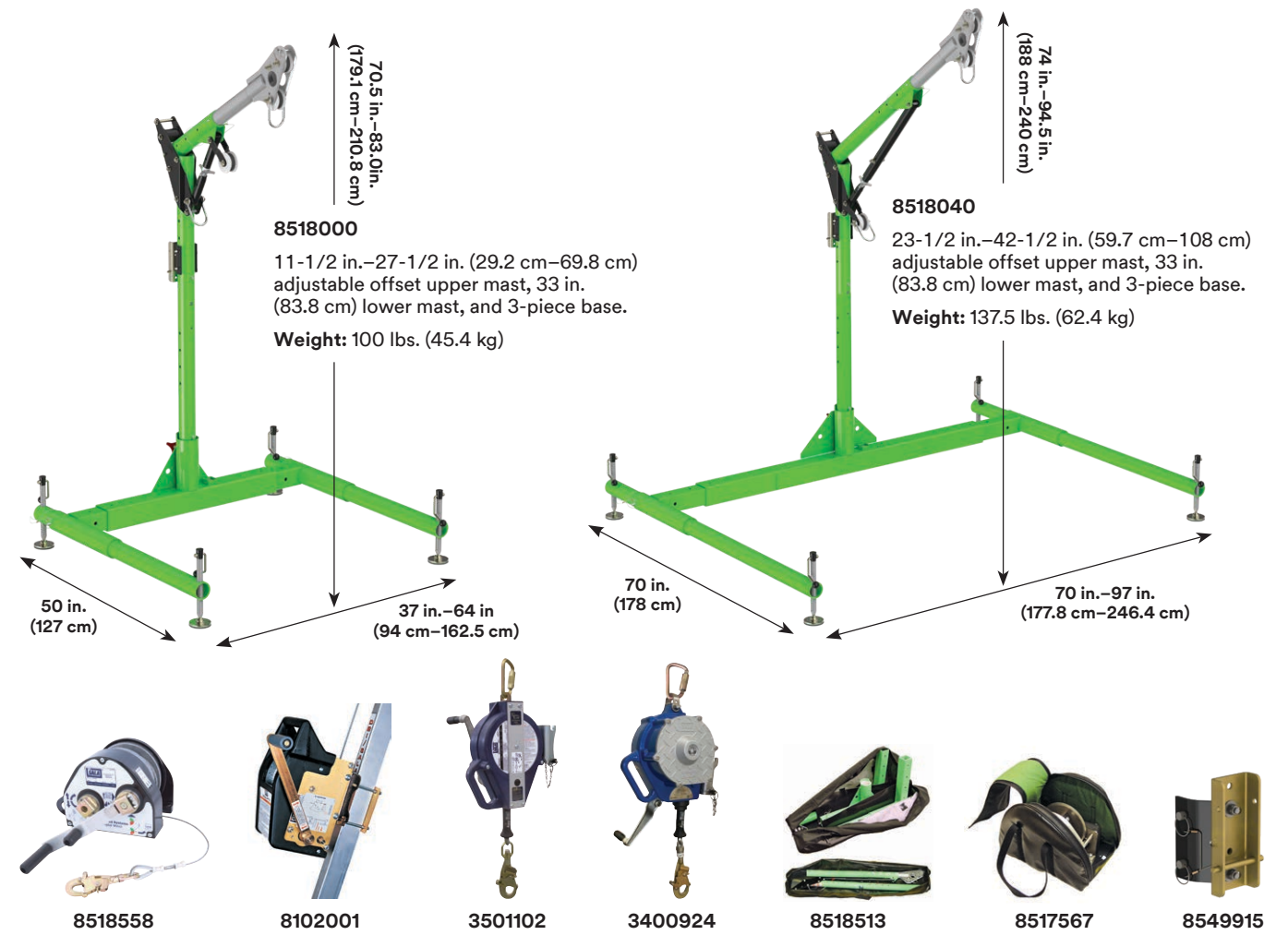

SKU	Short Reach 5-Piece Davit System	Long Reach 5-Piece Davit System	Digital Winch	Salalift™ II Winch	Ultra-Lok™ Retrieval SRL	Sealed-Blok™ Retrieval SRL	Davit Carrying Bags	Digital Winch Bags	Extra Winch Bracket
	8518000	8518040	8518558	8102001	3501102	3400924	8518513	8517567	8549915
8301100	■				■		■		
8301102	■		■				■	■	
8301103	■			■	■		■		■
8301105	■		■			■	■	■	■
8301107		■			■				
8301109		■	■					■	
8301110		■		■	■				■
8301112		■	■			■		■	■

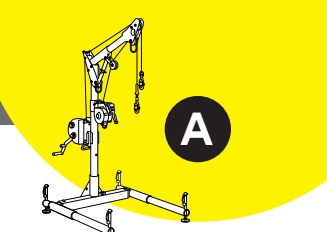

## Davit Systems (Cont.)

### Davit Arm Systems



**8530352**  
4-in-1 davit hoist system with integrated folding barrier. Includes winch/SRL mounting bracket.  
**Weight:** 125 lbs. (56.7 kg)

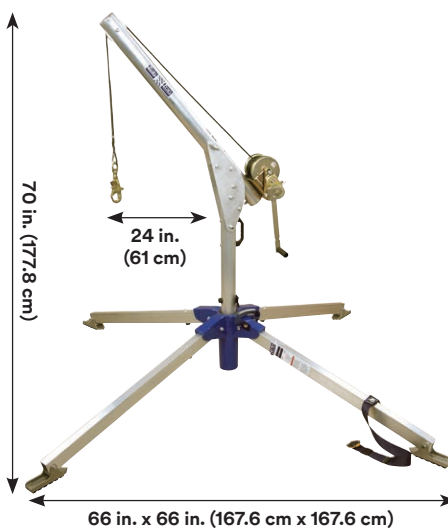

**8302500**  
2-piece rescue davit system with folding base and arm, and 50 ft. (15.2 m) synthetic rope winch. Designed for rescue, retrieval, and descent applications only.  
**Weight:** 76.2 lbs. (34.6 kg)

## Configurable Davit Systems

### Davit Arms - One Piece Adjustable Offset Davit Masts

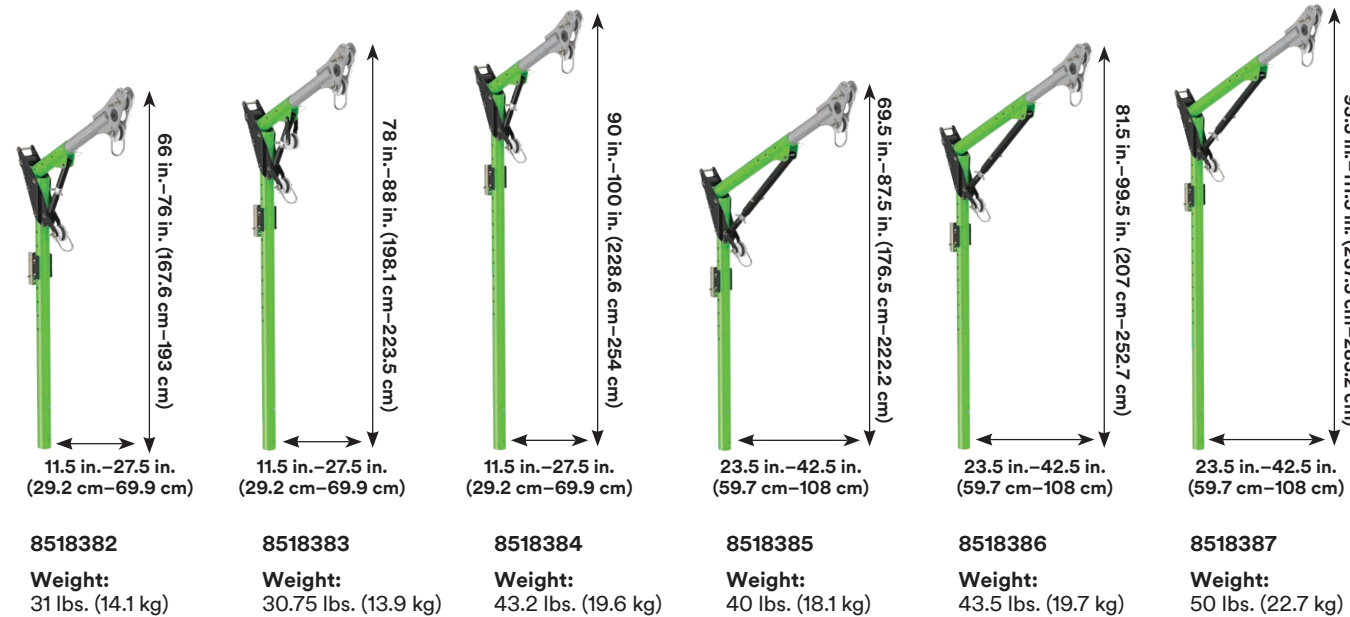

### Davit Arm - Adjustable Offset Upper Davit Masts

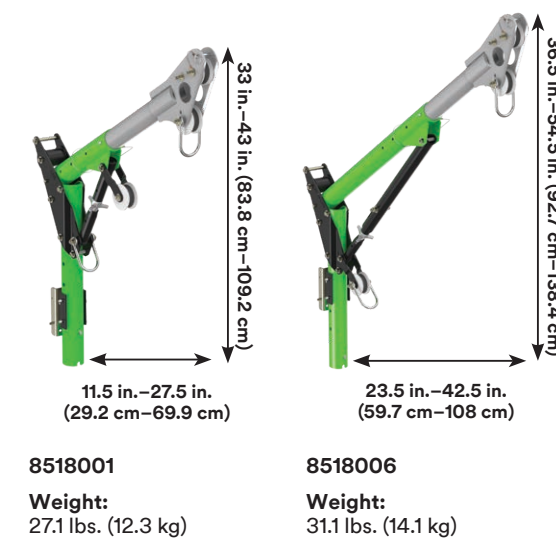

(Includes winch mount bracket)  
Combine these adjustable offset upper davit masts with up to two lower mast extensions to increase the davit height. Consult the compatibility charts.

### Lower Davit Mast Extensions

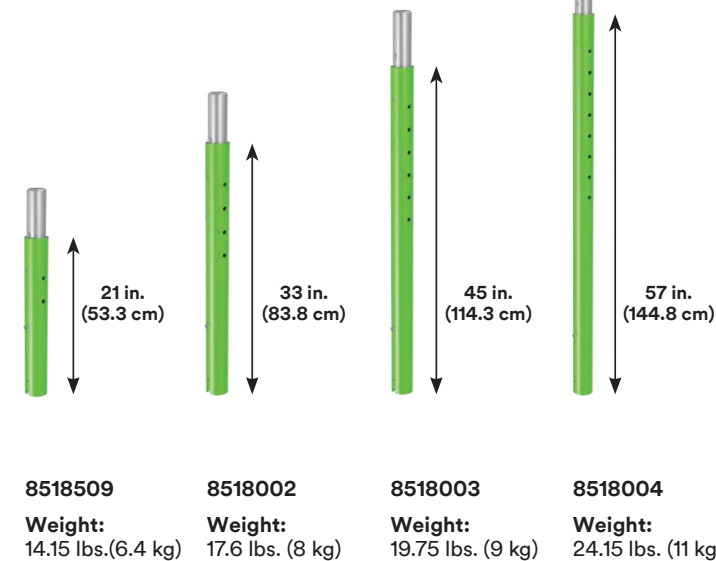

**NOTE:** Please reference compatibility chart on pages 24-25 for approved configurations, or visit [go.3M.com/ConfinedSpaceCompatibilityChart](http://go.3M.com/ConfinedSpaceCompatibilityChart) for an updated list.

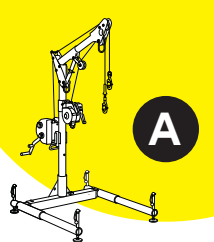

## Configurable Davit Systems (Cont.)

### Bases - Permanent

	<p><b>Model # 8516190</b>  <b>Floor Mount Sleeve</b>                      Zinc-plated mild steel construction. Mounts to horizontal concrete or steel structure. Comes with PVC sleeve liner.  <b>Weight:</b> 13 lbs. (5.9 kg)</p>
	<p><b>8518347</b>  <b>Floor Mount Sleeve</b>                      304 Stainless Steel  <b>Weight:</b> 13 lbs. (5.9 kg)</p>
	<p><b>8518503</b>  <b>Floor Mount Sleeve</b>                      Galvanized steel construction.  <b>Weight:</b> 13 lbs. (5.9 kg)</p>
	<p><b>Model # 8510109</b>  <b>Core Mount Sleeve</b>                      Zinc-plated mild steel construction. Designed for slip-in installation into 4" (10.2 cm) core hole in concrete or in an existing steel structure. Comes with PVC sleeve liner.  <b>Weight:</b> 8 lbs. (3.6 kg)</p>
	<p><b>8510110</b>  <b>Core Mount Sleeve</b>                      Stainless Steel  <b>Weight:</b> 8 lbs. (3.6 kg)</p>
	<p><b>Model # 8516191</b>  <b>Wall Mount Sleeve</b>                      Mild steel zinc-plated compact design construction. Compact design creates minimum intrusion into work space. Mounts to vertical concrete or steel structures. Comes with PVC sleeve liner.  <b>Weight:</b> 12 lbs. (5.4 kg)</p>
	<p><b>8518348</b>  <b>Wall Mount Sleeve</b>                      304 Stainless Steel construction.  <b>Weight:</b> 12 lbs. (5.4 kg)</p>
	<p><b>8518504</b>  <b>Wall Mount Sleeve</b>                      Galvanized steel construction.  <b>Weight:</b> 12 lbs. (5.4 kg)</p>
	<p><b>Model # 8530305</b>  <b>Offset Wall Mount Sleeve</b>                      14" (35.6 cm) offset wall mount sleeve, zinc plated steel construction, mounts to vertical surfaces.  <b>Weight:</b> 93 lbs. (42 kg)</p>
	<p><b>Model # 8510057</b>  <b>Offset Floor Mount Sleeve</b>                      Mild steel zinc-plated construction. Offset sleeve design enables the davit to be placed closer to the work location.  <b>Weight:</b> 25 lbs. (11.3 kg)</p>

### Bases - Permanent (Cont.)

	<p><b>Model # 8510311</b>  <b>Flush Floor Mount Sleeve</b>                      Mild steel zinc-plated construction. Comes with pins for fresh concrete and cast-in-place concrete anchors for new construction or renovation. Flush mount design allows passage of traffic and eliminates trip hazards when not in use. Comes with PVC sleeve liner.  <b>Weight:</b> 21 lbs. (9.5 kg)</p>
	<p><b>8512828</b>  <b>Flush Floor Mount Sleeve</b>                      Stainless steel construction. Comes with pins for fresh concrete installation.  <b>Weight:</b> 21 lbs. (9.5 kg)</p>
	<p><b>Model # 8510316</b>  <b>Flush Floor Mount Sleeve</b>                      Mild steel zinc-plated construction. Recessed fastener pockets allow for bolt-in installation into existing concrete or steel structure. Flush mount design allows passage of traffic and eliminates trip hazards when not in use. Comes with PVC sleeve liner.  <b>Weight:</b> 21 lbs. (9.5 kg)</p>
	<p><b>8512827</b>  <b>Flush Floor Mount Sleeve</b>                      Stainless steel construction for existing concrete installation.  <b>Weight:</b> 21 lbs. (9.5 kg)</p>
	<p><b>Model # 8512831</b>  <b>Center Mount Sleeve</b>                      Mild steel zinc-plated construction. Mounts to flat surfaces. Comes with PVC sleeve liner.  <b>Weight:</b> 13 lbs. (5.9 kg)</p>
	<p><b>8516563</b>  <b>Center Mount Sleeve</b>                      Stainless Steel  <b>Weight:</b> 13 lbs. (5.9 kg)</p>
	<p><b>Model # 8515162</b>  <b>Deck Mount Sleeve</b>                      Mild steel zinc-plated construction. Designed to slip into a 4" (10.2 cm) hole in existing flooring. Flush mount design allows passage of traffic and eliminates trip hazards when not in use. Comes with all necessary hardware. Mounts to thicknesses from 1/4" to 2" (6.4 mm–50.8 mm) max.  <b>Weight:</b> 17 lbs. (7.7 kg)</p>
	<p><b>8515834</b>  <b>Deck Mount Sleeve</b>                      Stainless steel. Includes plastic stopper &amp; mounting hardware.  <b>Weight:</b> 17 lbs. (7.7 kg)</p>

NOTE: Please reference compatibility chart on pages 24–25 for approved configurations, or visit [go.3M.com/ConfinedSpaceCompatibilityChart](http://go.3M.com/ConfinedSpaceCompatibilityChart) for an updated list.

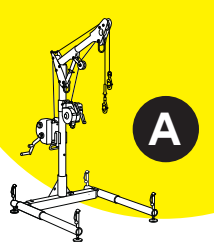

## Configurable Davit Systems (Cont.)

### Bases - Freestanding & Counterweighted

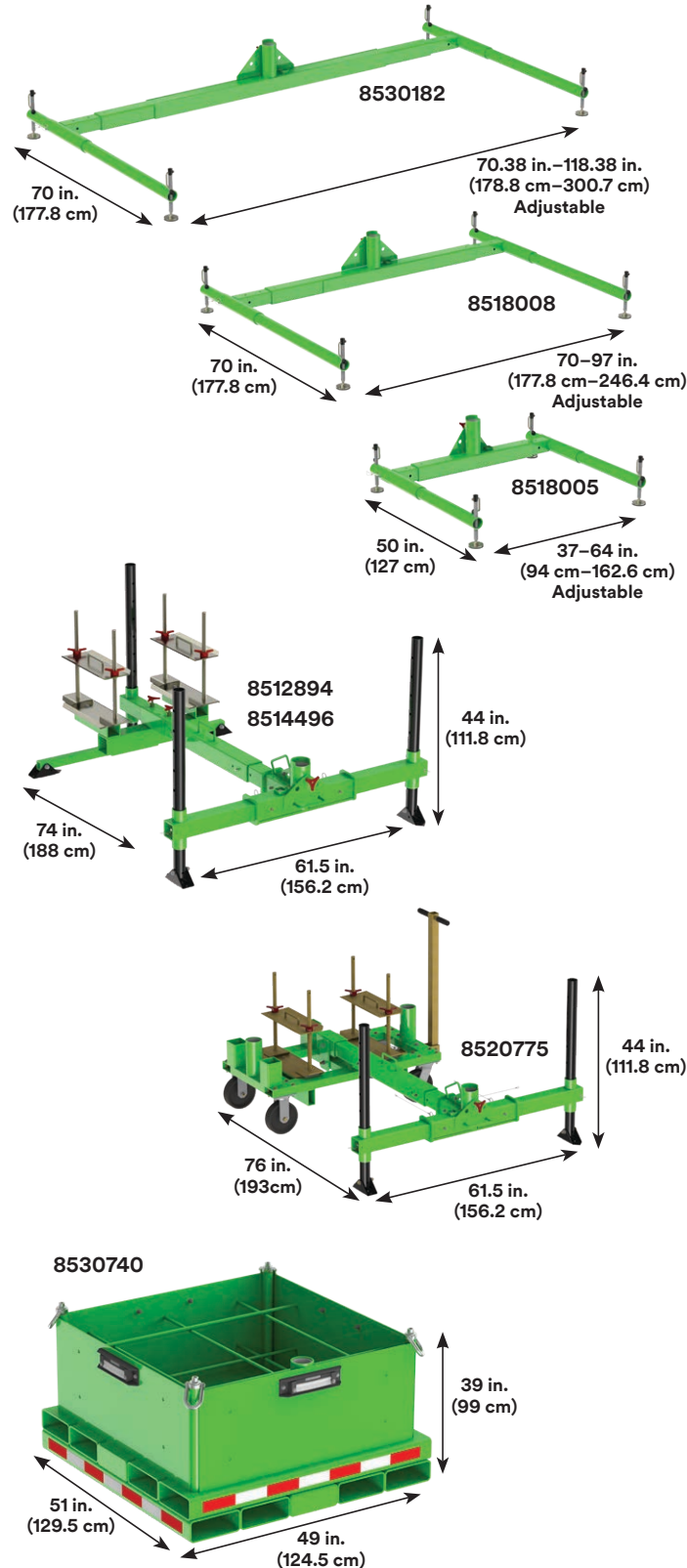

<b>Model # 8530182</b>	<b>Extra Wide Expandable Base</b> Extra wide 3-piece expandable base for use with either 42.5" (108 cm) or 27.5" (69.9 cm) maximum offset davit masts. <b>Weight:</b> 80.2 lbs. (36.4 kg)
<b>8518008</b>	<b>Expandable Base</b> 3-piece expandable base for use with either 42.5" (108 cm) or 27.5" (69.9 cm) maximum offset davit masts. <b>Weight:</b> 92 lbs. (41.7 kg)
<b>8518005</b>	<b>Expandable Base</b> 3-piece expandable base for use with 27.5" (69.9 cm) maximum offset davit masts only. <b>Weight:</b> 60 lbs. (27.2 kg)
<b>Model # 8512894</b>	<b>Portable Counterweighted Rack Davit Base with Pole Leg Adjustment</b> Counterweighted rack davit base designed to be disassembled and easily transported. Note: Steel counterweight plates, winch and davit not included. <b>Weight:</b> 199 lbs. (90.3 kg)
<b>8514496</b>	<b>Portable Counterweighted Rack Davit Base with Screw Leg Adjustment</b> Counterweighted rack davit base designed to be disassembled and easily transported. Note: Steel counterweight plates not included. <b>Weight:</b> 192 lbs. (87.1 kg)
<b>8520775</b>	<b>Portable Counterweighted Cart Davit Base with Pole Leg Adjustment</b> Counterweighted cart davit base designed to be easily transported using integrated urethane casters. Note: Steel counterweight plates not included. <b>Weight:</b> 356 lbs. (161.5 kg)
<b>Model # 8530740</b>	<b>Portable Counterweighted Concrete Filled Davit Base</b> Counterweighted davit base designed to be easily transported using a forklift. Note: 4,000 PSI concrete not included. <b>Weight:</b> 1,252 lbs. (567.9 kg)

### Bases - Integrated

#### Adjustable Catwalk Clamp

STEP 1: Select a clamp	
<b>Model # 8530078</b>	Aluminum constructed clamp assembly with a clamp range (A) of 1/2"–32" (1.3 cm–81.3 cm). Compatible with long and short reach davit arms. Note: (A) on diagram below. <b>Weight:</b> 37 lbs. (16.8 kg)
<b>8540774</b>	Aluminum constructed clamp assembly with a clamp range (A) of 9.5"–21.5" (24.1 cm–54.6 cm). Compatible with short reach davit arms. Note: (A) on diagram below. <b>Weight:</b> 28 lbs. (12.7 kg)
STEP 2: Select outriggers	
<b>8514418</b>	Outrigger with screw adjustment for use with 8530078 clamp. Order quantity 2 to complete system.
<b>8512900</b>	Outrigger with screw adjustment for use with 85400774 clamp. Order quantity 2 to complete system.

STEP 4: Select an extension tube			
Aluminum Extension Tube	8540774 Clamp (B) Nominal Length	8530078 Clamp (B) Length Range	
<b>8540773</b> 3.5 lbs. (1.6 kg)	26.75" (67.9 cm)	N/A	N/A
<b>8524573</b> 4.7 lbs. (2.1 kg)	30.75" (78.1 cm)	51.31" (130.3 cm)	49.31" (125.2 cm)
<b>8521280</b> 7.1 lbs. (3.2 kg)	37.38" (94.9 cm)	57.94" (147.2 cm)	49.94" (126.8 cm)
<b>8521281</b> 10.7 lbs. (4.9 kg)	49.38" (125.4 cm)	69.88" (177.5 cm)	57.88" (147 cm)
<b>8521282</b> 14.2 lbs. (6.4 kg)	61.38" (155.9 cm)	81.98" (208.2 cm)	69.88" (177.5 cm)
<b>8521283</b> 17.8 lbs. (8.1 kg)	73.38" (186.4 cm)	93.88" (238.5 cm)	81.88" (208 cm)
<b>8521284</b> 21.4 lbs. (9.7 kg)	85.38" (216.9 cm)	105.88" (268.9 cm)	93.88" (238.5 cm)

**NOTE:** Shorter outriggers available for specific configurations. Refer to IFU for more detailed information.

STEP 3: Add center section	
<b>8513593</b>	For Counterweight System. Center section with davit sleeve required for catwalk clamp system. <b>Weight:</b> 22 lbs. (10 kg)

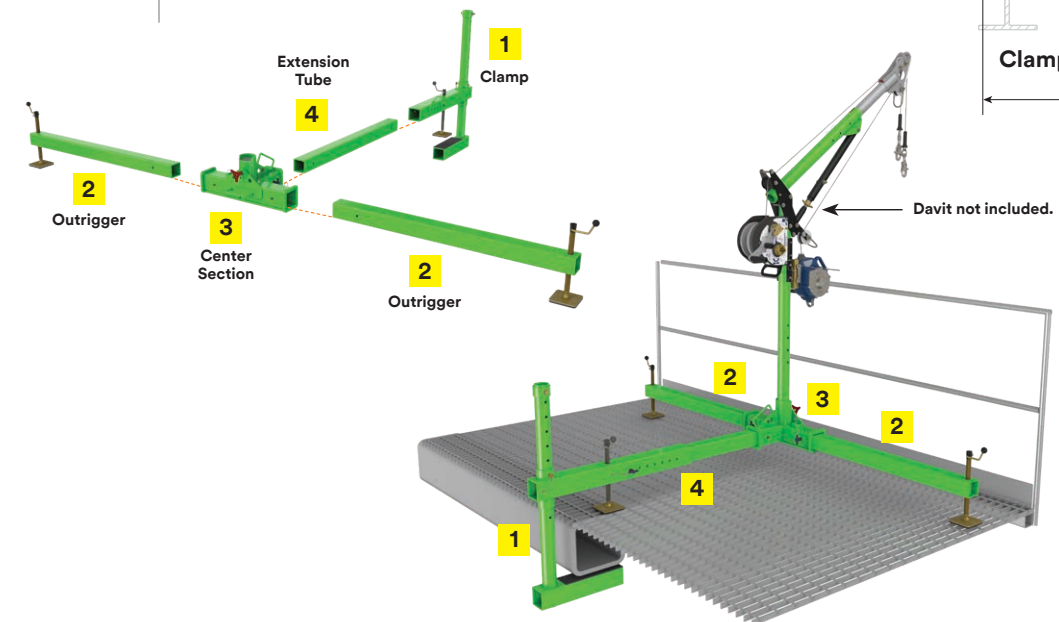



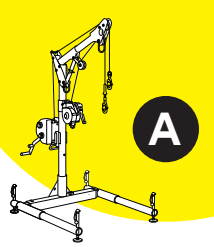



**NOTE:** Please reference compatibility chart on pages 24–25 for approved configurations, or visit [go.3M.com/ConfinedSpaceCompatibilityChart](http://go.3M.com/ConfinedSpaceCompatibilityChart) for an updated list.



## Configurable Davit Systems (Cont.)

### Bases - Integrated (Cont.)

	<b>8510323</b>	<b>Model # 8510323</b> <b>Barrel Mount Sleeve</b> Clamp on davit base with 3.5" (8.9 cm) maximum opening, zinc plated. <b>Weight:</b> 36.5 lbs. (16.6 kg)
	<b>8510429</b>	<b>Barrel Mount Sleeve</b> Clamp on davit base with 3.5" (8.9 cm) maximum opening, 304 stainless steel. <b>Weight:</b> 36.5 lbs. (16.6 kg)
	<b>8530268</b>	<b>Barrel Mount Sleeve</b> Clamp on davit base with 4.5" (11.4 cm) maximum opening, zinc plated. <b>Weight:</b> 35 lbs. (15.9 kg)
	<b>8510715</b>	<b>Adjustable Barrel Mount Sleeve</b> Clamp on davit base with 12" (30.5 cm) maximum opening. <b>Weight:</b> 52.6 lbs. (23.9 kg)
	<b>8512285</b>	<b>Adjustable Barrel Mount Sleeve</b> Clamp on davit base with 24" (61 cm) maximum opening. <b>Weight:</b> 68 lbs. (30.8 kg)
	<b>8516005</b>	<b>Adjustable Strap Mount</b> Designed to strap vertically to structures up to 60" (152.4 cm) in diameter. <b>Weight:</b> 36 lbs. (16.3 kg)
	<b>8519377</b>	<b>Tank Flange Base</b> Used on manways with a flange structure that the unit may be secured onto. This collar can clamp onto 6" (15.2 cm) max thick flange. <b>Weight:</b> 82 lbs. (37.2 kg)
	<b>8520267</b>	<b>Tank Flange Base</b> Fits flanges with a bolt circle diameter of 18" to 36" (45.7 cm to 91.4 cm) simple attachment with three bolts. Pivoting arms accommodate various manways. Can be used with 8525274 clamp-on studs, see tank pod section. <b>Weight:</b> 61 lbs. (27.7 kg)
	<b>8510140</b>	<b>Vehicle Hitch Mount Sleeve</b> Designed to install into a 2" (5.1 cm) hitch receiver on an attendant vehicle providing a highly portable davit base. Designed for 11.5"-27.5" (29.2 cm to 69.9 cm) offset davit. <b>Weight:</b> 57 lbs. (25.9 kg)
	<b>8514461</b>	<b>Vehicle Hitch Mount Sleeve</b> Designed for 23.5"-42.5" (59.7 cm to 108 cm) offset davit. <b>Weight:</b> 62 lbs. (28.1 kg)

### Bases - Integrated (Cont.)

	<b>8514503</b>	<b>Model # 8514503</b> <b>Extension Tube 2'</b> (61 cm) Sleeve Extension for Vehicle Hitch Mount. <b>Weight:</b> 17 lbs. (7.7 kg)
	<b>8512829</b>	<b>Extension Tube 4'</b> (1.2 m) Sleeve Extension for Vehicle Hitch Mount. <b>Weight:</b> 27.8 lbs. (12.6 kg)
	<b>8511384</b>	<b>Extension Tube 6'</b> (1.8 m) Sleeve Extension for Vehicle Hitch Mount. <b>Weight:</b> 39 lbs. (17.7 kg)
	<b>8511401</b>	<b>Model # 8511401</b> <b>Universal Joint Assembly</b> The universal joint assembly installs between the 8510140 hitch mount sleeve or extension allowing the base to be pivoted about the vehicle hitch. Please refer to user instructions to ensure compliance with any usage limitations. <b>Weight:</b> 10 lbs. (4.5 kg)
	<b>8520886</b>	<b>8520886</b> <b>Universal Hitch Ball Coupler</b> The universal hitch ball coupler is used to connect the vehicle hitch mounted sleeve to 1-7/8", 2", and 2-5/16" hitch balls. <b>Weight:</b> 16 lbs. (7.3 kg)
	<b>8511892</b>	<b>Model # 8511892</b> <b>Portable Rail Clamping Base</b> Ideal for rail accessed areas, including over the edge of a rail bridge. System comes complete with a rail bridge clamp which anchors the base, 36" (91.4 cm) inner extension tube, center section, and two outrigger screw assemblies. <b>Weight:</b> 92 lbs. (41.7 kg)
	<b>8510501</b>	<b>Model # 8510501</b> <b>Manhole Collar</b> Designed for applications involving frequent setups over similarly sized access openings. Lightweight, powder-coated aluminum construction for portability. 17.5" (44.5 cm) Manhole Collar for use on manways 18"-20" (45.7 cm-50.8 cm).
	<b>8510520</b>	19.5" (49.5 cm) Manhole collar for use on manways 20"-22" (50.8 cm-55.9 cm) in diameter.
	<b>8510457</b>	21.5" (54.6 cm) Manhole collar for use on manways 22"-24" (55.9 cm-61 cm) in diameter.
	<b>8510163</b>	23.5" (59.7 cm) Manhole collar for use on manways 24"-26" (61 cm-66 cm) in diameter.
	<b>8510633</b>	25.5" (64.8 cm) Manhole collar for use on manways 26"-28" (66 cm-71.1 cm) in diameter.
	<b>8510632</b>	27.5" (69.9 cm) Manhole collar for use on manways 28"-30" (71.1 cm-76.2 cm) in diameter.
	<b>8510546</b>	29.5" (74.9 cm) Manhole collar for use on manways 30"-32" (76.2 cm-81.3 cm) in diameter.
	<b>8530312</b>	31.5" (80 cm) Manhole collar for use on manways 32"-34" (81.3 cm-86.4 cm) in diameter.
	<b>8512994</b>	33.5" (85 cm) Manhole collar for use on manways 34"-36" (86.4 cm-91.4 cm) in diameter.

NOTE: Please reference compatibility chart on pages 24-25 for approved configurations, or visit [go.3M.com/ConfinedSpaceCompatibilityChart](http://go.3M.com/ConfinedSpaceCompatibilityChart) for an updated list.



## Configurable Davit Systems (Cont.)

### Bases - Integrated (Cont.)

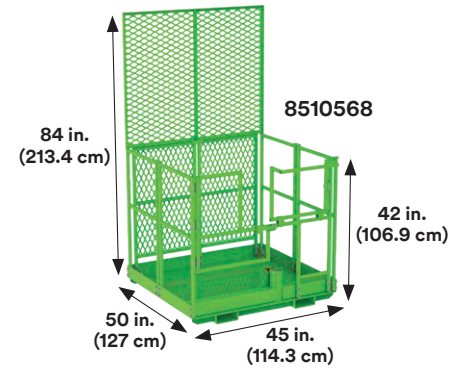

<b>Model #</b> 8510568	<b>Forklift Basket</b> Designed to convert your forklift into a versatile confined space and fall arrest work platform. Integrated davit sleeve will accommodate short reach davits up to 27.5" (69.9 cm) reach. Lightweight aluminum construction and tool-free assembly simplifies setup, transport and storage. Powder-coated finish with anti-slip finish on walking surfaces. Includes spring-loaded gate. <b>Weight:</b> 215 lbs. (97.5 kg)
---------------------------	---



<b>Model #</b> 8521230	<b>Forklift Basket</b> Forklift basket platform with two integrated anchorages provides a safe means of access to elevated surfaces. Integrated fork pockets and chain fastening system hold this work platform securely to the forklift. Constructed of durable powder coated steel. <b>Weight:</b> 443 lbs. (200.9 kg)
---------------------------	--

### Accessories



<b>Model #</b> 8518270	Equipment cart for 5-piece davit systems 8518000 & 8518040.
<b>Model #</b> 8549915	Davit arm winch/SRL mounting bracket assembly. Extra bracket required when adding additional winch or retrieval SRL to a davit system.
<b>Model #</b> 8510207	Winch/SRL adapter with flat back.
<b>Model #</b> 8516824	Quick release mounting bracket for upper and lower masts.
<b>Model #</b> 8510826	Heavy-Duty Sleeve Cap, mild steel zinc-plated construction.
<b>Model #</b> 8510827	Heavy-Duty Sleeve Cap, stainless steel construction.
<b>Model #</b> 8518513	Set of 2 carrying bags for 5-piece hoist. Used for transporting the 8518000 short reach 5-piece davit system.
<b>Model #</b> 8513330	Carrying bag with protective plastic liner. Used for transporting one piece adjustable offset davit masts.

NOTE: Please reference compatibility chart on pages 24–25 for approved configurations, or visit [go.3M.com/ConfinedSpaceCompatibilityChart](http://go.3M.com/ConfinedSpaceCompatibilityChart) for an updated list.

## 3M™ DBI-SALA®

### Tripod Systems

The 3M™ DBI-SALA® Confined Space Tripod is constructed of tubular lightweight aluminum and a rugged steel head assembly. These tripods are extremely lightweight and portable, easily set up by one worker and can be transported from one location to another. Designed for confined space entry and emergency rescue applications, they can accommodate a variety of winches and fall arrest devices. 3M tripods are also loaded with features such as spring-loaded locking legs, simple detent pin style adjustment, quick-mount mechanical device brackets, safety chains to prevent movement, and safety shoes that incorporate a rubber sole for flat surfaces and spiked edges for slippery surfaces.

#### 1 Integrated Re-Directional Pulleys

Integrated pulleys are top mounted for smooth operation.

#### 2 Spring-Loaded Tripod Legs

Spring-loaded leg assemblies snap securely into position when fully deployed, eliminating the need for pins.

#### 3 5,000 lb. (22 kN) Rated Anchor Points

Two integrated 5,000 lb. (22 kN) anchor points provide many versatile and robust anchoring options.

#### 4 Safety & Inspection Manager Capable

Equipped with a RFID tag to streamline your safety and asset management.

#### 5 Accessories

A multitude of accessories provides the options and versatility needed to tackle unique confined space challenges.

#### 6 Connecting Devices

Can support up to four connecting devices (winches/SRLs) for complete flexibility

#### 7 Anodized Aluminum Construction

Lightweight yet durable construction for ease of use and longevity.

#### 8 Telescopic Legs

Provide integrated means of leveling and adjustment. Legs are securely locked with steel detent pins.

#### 9 Safety Chains

Provides added support and strength for demanding confined space applications.

#### 10 Foot Pads

Pivoting footpads have built in sharp points for digging into soft and/or uneven terrain.

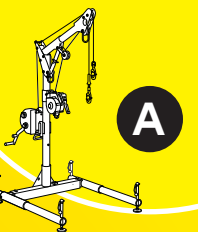

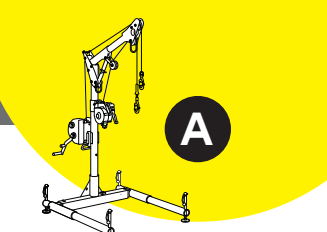

**Tripods**



**Complete Tripod Solutions**

SKU	7' Alum. Tripod	9' Alum. Tripod	Lifeline Type	Salalift™ II Winch	Sealed-Blok™ Retrieval SRL	Ultra-Lok™ Retrieval SRL	Tripod Carrying Bag	Winch/SRL Mounting Bracket	Leg Mount Pulley
	8000000	8000010							
8300030	■		Galvanized	60 ft. (18.3 m)					
8300032	■		Galvanized	90 ft. (27.4 m)					
8300034	■		Galvanized	120 ft. (36.6 m)					
8301030	■		Galvanized		50 ft. (15.2 m)				
8301041	■		Galvanized	60 ft. (18.3 m)	50 ft. (15.2 m)			■	■
8301062	■		Galvanized			50 ft. (15.2 m)	■		
8301066	■		Galvanized	60 ft. (18.3 m)		50 ft. (15.2 m)	■	■	■
8300040		■	Galvanized	60 ft. (18.3 m)					
8301035		■	Galvanized		50 ft. (15.2 m)				
8301049		■	Galvanized		85 ft. (25.9 m)				
8301043		■	Galvanized	60 ft. (18.3 m)	50 ft. (15.2 m)			■	■
8301064		■	Galvanized			50 ft. (15.2 m)	■		
8301068		■	Galvanized	60 ft. (18.3 m)		50 ft. (15.2 m)	■	■	■
8300031	■		Stainless Steel	60 ft. (18.3 m)					
8300033	■		Stainless Steel	90 ft. (27.4 m)					
8300035	■		Stainless Steel	120 ft. (36.6 m)					
8301031	■		Stainless Steel		50 ft. (15.2 m)				
8301042	■		Stainless Steel	60 ft. (18.3 m)	50 ft. (15.2 m)			■	■
8301063	■		Stainless Steel			50 ft. (15.2 m)	■		
8301067	■		Stainless Steel	60 ft. (18.3 m)		50 ft. (15.2 m)	■	■	■
8300041		■	Stainless Steel	60 ft. (18.3 m)					
8301036		■	Stainless Steel		50 ft. (15.2 m)				
8301037		■	Stainless Steel		85 ft. (25.9 m)				
8301044		■	Stainless Steel	60 ft. (18.3 m)	50 ft. (15.2 m)			■	■
8301065		■	Stainless Steel			50 ft. (15.2 m)	■		
8301069		■	Stainless Steel	60 ft. (18.3 m)		50 ft. (15.2 m)	■	■	■

**Configurable Tripod Solutions**

3M™ DBI-SALA® Confined Space Aluminum Tripods feature telescoping adjustable locking legs, a built-in pulley system, rubber safety shoes with spiked edges and a safety leg support chain. The integrated 5,000 lb. (22 kN) eyebolt anchor points and quick connect winch/SRL mount bracket make for straightforward connection points. 350 lb. (159.0kg) working load capacity.



8000000 Inside of shoe = 44 in.–63 in. (111.8 cm–160 cm)  
8000010 Inside of shoe = 65 in.–184 in. (165.1 cm–467.4 cm)

Model #	3M™ DBI-SALA® Aluminum Tripod
8000000	7' (2.1 m) aluminum tripod with adjustable locking legs, safety chains, top pulley and winch bracket.
8000010	9' (2.7 m) aluminum tripod with adjustable locking legs, safety chains, top pulley and winch bracket.
8003238	<b>Leg Mount Pulley</b> Attaches to tripod leg for routing of winch or SRL cable.
8005048	<b>Tripod Mounting Base</b> Attaches to tripod leg, mates with 8100070 winch base.
8003205	<b>Tripod Pulley</b> Attaches to tripod eye bolt for routing of winch or SRL cable.
9503094	Carrying bag for 7' (2.1 m) tripod with protective plastic liner.
9503095	Carrying bag for 9' (2.7 m) tripod with protective plastic liner.

3M™ DBI-SALA® UCT Aluminum Tripods are constructed of lightweight aluminum, and feature adjustable height models up to 10 ft. (3 m). This tripod can be equipped with up to three pulleys to accommodate a variety of winches and fall arrest devices. Integrated 5,000 lb. (22 kN) anchor points readily accept standard carabiners and are ideal for attaching secondary backup systems. 450 lb. (204.1 kg) working load capacity.



8513158 Inside of shoe = 41 in.–68 in. (104.1 cm–172.7 cm)  
8513159 Inside of shoe = 59 in.–100 in. (149.9 cm–254 cm)

Model #	3M™ DBI-SALA® UCT Aluminum Tripod
8513158	7' (2.1 m) aluminum tripod with adjustable locking legs, safety chains, top pulley and winch bracket.
8513159	10' (3 m) aluminum tripod with adjustable locking legs, safety chains, top pulley and winch bracket.
8512293	<b>Top Pulley Assembly for UCT Series Tripods</b> Pulleys are mounted on top of the head assembly for routing mechanical device's lifeline.
8510224	<b>Winch/SRL Mounting Bracket</b> Attaches to tripod (8513158) with quick-release pins for tool-free setup and adjustment.
8512292	<b>Winch/SRL Mounting Bracket</b> Attaches to tripod (8513159) with quick-release pins for tool-free setup and adjustment.
8513329	Carrying bag for 7' (2.1 m) tripod with protective plastic liner.
8513330	Carrying bag for 10' (3 m) tripod with protective plastic liner.

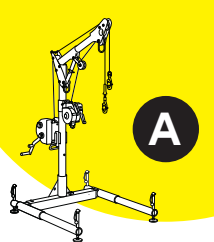

## 3M DBI-SALA Confined Space Portable Fall Arrest Post

### Portable Fall Arrest Posts

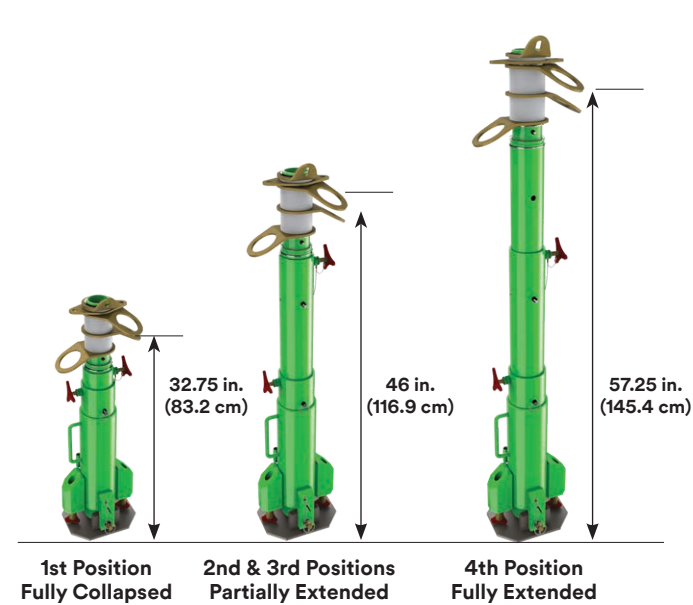

Our portable fall arrest post allows for up to three workers on top of transformers or other types of vertical platforms with potential fall hazards. The system features a telescopic design and 3 swiveling anchor points providing up to 3 workers with 360 degrees of protection and mobility. Connect up to two Portable Fall Arrest Posts (8516691) for use in Horizontal Lifeline Applications. See user instructions for specific installation requirements.

<b>Model # 8516691</b>	<b>Portable Fall Arrest System</b> The system has 3 telescopic working heights ranging from 30.5" (127.8 cm), 43" (109.3 cm), all the way up to 54.5" (138.5 cm).
<b>8516996</b>	<b>14' (4.3 m) Uni-Anchor Fall Arrest Post</b> The 14' (4.3 m) uni-anchor fall arrest post mounts using uni-anchor plates and extends up to 14' (4.3 m) to provide a 1-man-rated fall arrest anchor point. <b>Weight: 71 lbs. (32.2 kg)</b>

8516691 and 8516696 are compatible with all bases listed below.

8516996

### Portable Fall Arrest Post - Bases

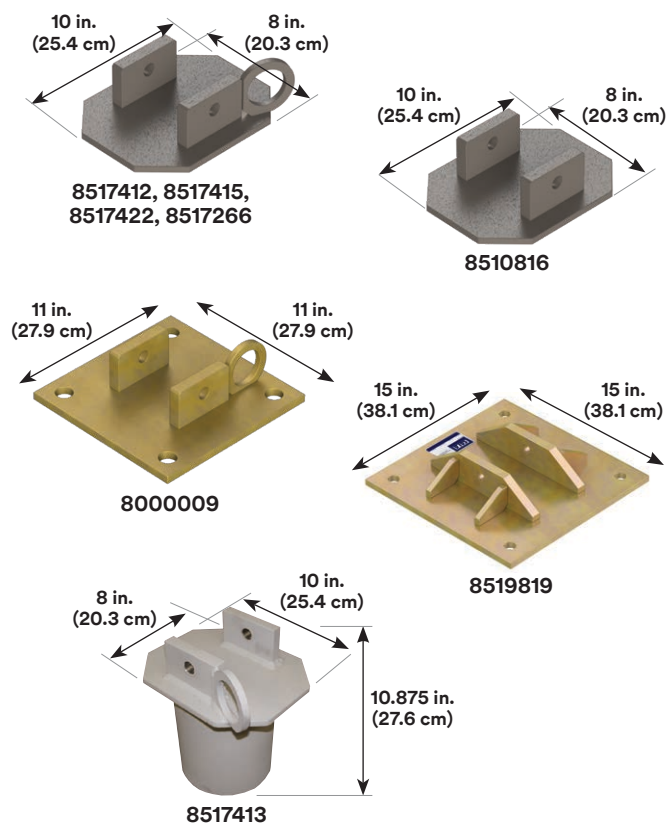

<b>Model # 8517412</b>	<b>Bare Steel Uni-Anchor with Tie-Off Anchor</b> For use in closed environments without chemical or moisture exposure. <b>Weight: 11.6 lbs. (5.3 kg)</b>
<b>8517415</b>	<b>Stainless Steel Uni-Anchor with Tie-Off Anchor</b> <b>Weight: 11.6 lbs. (5.3 kg)</b>
<b>8517422</b>	<b>Sandblasted Uni-Anchor with Tie-Off Anchor</b> <b>Weight: 11.6 lbs. (5.3 kg)</b>
<b>8517266</b>	<b>Primer Finish Uni-Anchor with Tie-Off Anchor</b> <b>Weight: 12 lbs. (5.4 kg)</b>
<b>Model # 8510816</b>	<b>Weld-on Mounting Plate</b> Unplated mild steel construction. <b>Weight: 11.6 lbs. (5.3 kg)</b>
<b>Model # 8000009</b>	<b>Bolt-On Uni-Anchor with Tie-Off Zinc Plated</b> Zinc plated uni-anchor with tie-off, bolt-on. <b>Weight: 21 lbs. (9.5 kg)</b>
<b>8519819</b>	<b>Bolt-On Uni-Anchor with Tie-Off Zinc Plated</b> Larger footprint for use on concrete surfaces.
<b>Model # 8517413</b>	<b>Bare Steel Weld-On Base with Tie-Off Anchor</b> Can be modified for angled/sloped applications.

### Portable Fall Arrest Post Accessories

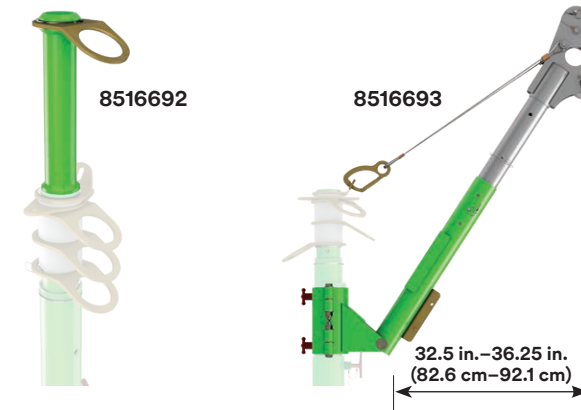

<b>Model # 8516692</b>	<b>14" (35.6 cm) Anchor Post Extension</b> Allows for tie-off of one worker at an increased height of 68.5" (174 cm) <b>Weight: 5 lbs. (2.3 kg)</b>
<b>8516693</b>	<b>Portable Fall Arrest Post Rescue Davit Arm</b> <b>Weight: 20.5 lbs. (9.3 kg)</b>
<b>8517565</b>	<b>Heavy-Duty Carrying Bag</b> For 8516691 portable fall arrest post only.

## Tank Pod System

### Tank Pod System



<b>Model # 8513700</b>	<b>Tank Pod</b> Ideal for situations with low overhead clearance, or when the surrounding area is not suitable for a davit or tripod system. Secures to tank entry flanges via clamp-on studs (8525274), or directly to 5/8"-11 UNC studs. Adapters are optionally available to adapt this system to either 1/2" or 3/4" studs.
<b>8515299</b>	<b>Stud Extension Adapter</b> 1/2"-5/8" (6.4 mm-15.9 mm) UNC stud adapter.
<b>8515301</b>	<b>Stud Extension Adapter</b> 3/4"-5/8" (19.1 mm-15.9 mm) UNC stud adapter.
<b>8525274</b>	<b>Stainless Steel Clamp-On Studs</b> Clamps to tank flanges to provide a secure base for mounting.

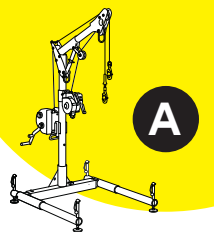

## Side Entry System

### Side Entry System

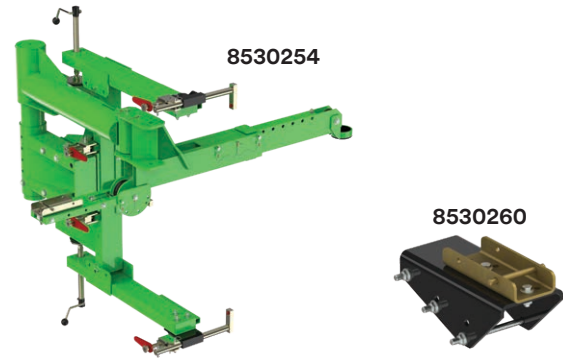

<b>Model #</b> 8530254	<b>Side Entry System</b> Designed for single user confined space entry/retrieval and rescue operations involving horizontal entries with vertical positioning or retrieval required inside the space. Fits 22"-56" (55.9 cm-142.2 cm) diameter manways with a flange thickness ranging from 1"-6" (2.5 cm-15.2 cm). <b>Weight:</b> 148 lbs. (67.1 kg)
8530260	<b>Secondary Winch/SRL Mounting Bracket</b> <b>Weight:</b> 5 lbs. (2.3 kg)

### Side Entry System - Floor Mounted

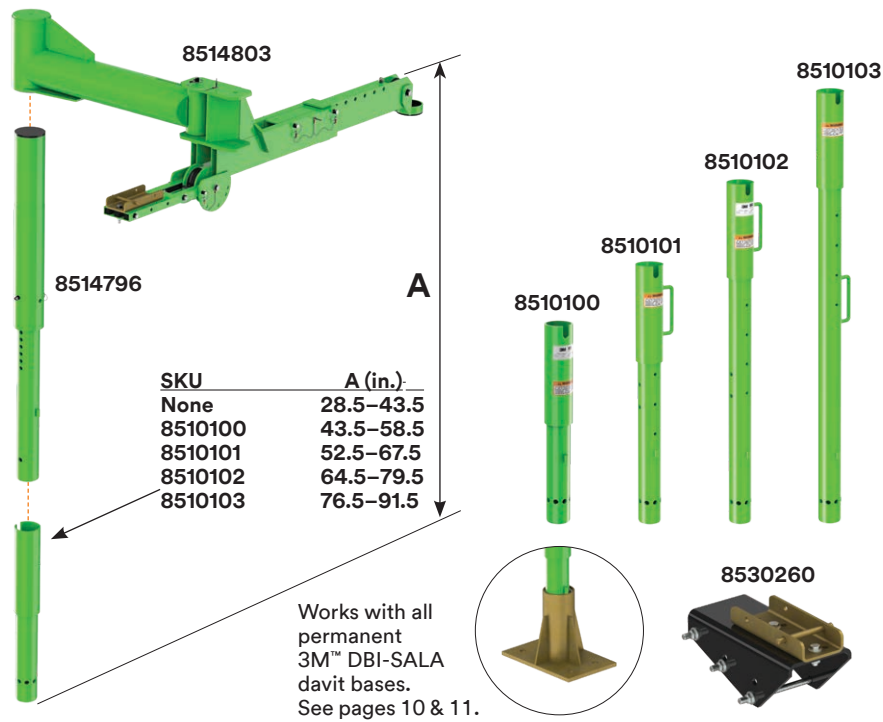

SKU	A (in.)
None	28.5-43.5
8510100	43.5-58.5
8510101	52.5-67.5
8510102	64.5-79.5
8510103	76.5-91.5

Works with all permanent 3M™ DBI-SALA davit bases. See pages 10 & 11.

<b>Model #</b> 8514803	<b>Arm Assembly, Side Entry System</b> <b>Weight:</b> 57.6 lbs. (26.1 kg)
8514796	<b>Support Post</b> 28.5"-43.5" (96.5 cm-135.9 cm) <b>Weight:</b> 32.6 lbs. (14.8 kg)
8510100	15" (38.1 cm) Mast Extension <b>Weight:</b> 16 lbs. (7.3 kg)
8510101	24" (61 cm) Mast Extension <b>Weight:</b> 19 lbs. (8.6 kg)
8510102	36" (91.4 cm) Mast Extension <b>Weight:</b> 23 lbs. (10.4 kg)
8510103	48" (121.9) Mast Extension <b>Weight:</b> 27 lbs. (12.2 kg)
8530260	<b>Secondary Winch/SRL Mounting Bracket</b> <b>Weight:</b> 5 lbs. (2.3 kg)

### Restricted Space Side Entry System

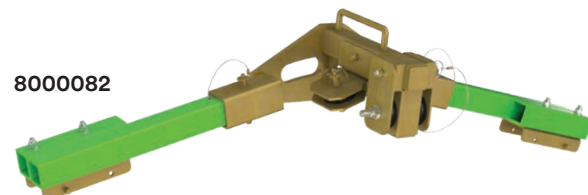

<b>Model #</b> 8000082	<b>Restricted Space Side Entry System</b> Fastens directly to man-way entries, enabling rescue and retrieval for up to two workers. Mounting hardware not included. <b>Weight:</b> 45 lbs. (20.4 kg)
---------------------------	--

## Pole Hoist System

The pole hoist attaches with a carabiner on the universal bracket to a suitable anchor point, allowing you to work in any direction from any angle. It has a unique swivel head that rotates 360 degrees, providing flexibility in both vertical and horizontal confined space entries.



### Complete Pole Hoist Systems

SKU	Pole Hoist	Digital Series Winch	Ultra-Lok™ Retrieval SRL	Digital Winch Bag
	8530252	8518560	3501102	8517567
8301114	■	■		■
8301115	■		■	

<b>Model #</b> 8530252	<b>Extendable Pole Hoist, 4'-7' (1.2 m-2.1 m)</b> Extension with swivel head and winch mounting bracket, T-bar leg assembly and hardware/fasteners. <b>Weight:</b> 12 lbs. (5.4 kg)
8530253	<b>Extendable Pole Hoist, 6'-10' (1.8 m-3 m)</b> Extension with swivel head and winch mounting bracket, T-bar leg assembly and hardware/fasteners. <b>Weight:</b> 14 lbs. (6.4 kg)

### Pole Hoist Anchors & Accessories



<b>Model #</b> 3620008	<b>Web Sling</b> 6,000 lb. rated, 1' (30.5 cm) long; 3/4" (19.1 mm) wide Kevlar® web anchor sling.
2104550	<b>Steel Anchor Plate with D-Ring</b> This plate anchor offers a compact, reliable attachment to 3/8"-1" (9.5 mm-25.4 mm) thick plate steel for connecting your lanyard, vertical lifeline system or self-retracting lifeline.
8520777	<b>Clamp-On Anchor for Pole Hoists</b> Designed to secure to a vertical or horizontal flange up to 6" (15.2 cm) thick and provide an anchorage point to connect a pole hoist device to.
8513329	Carrying Bag for 4'-7' (1.2 m-2.1 m) pole hoist.
8513330	Carrying Bag for 6'-10' (1.8 m-3 m) pole hoist.



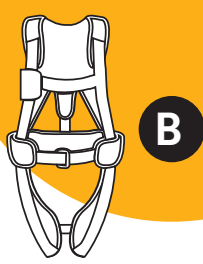

## You need the right harness for your application.

Depending on your application, the harness you choose matters. Make sure you're rescue-ready with the correct harness.

- ▶ **If raising and lowering is the primary means of egress:**  
3M™ DBI-SALA® ExoFit NEX™ with Back & Front D-Ring
- ▶ **If a ladder is the primary means of egress:**  
3M™ DBI-SALA® ExoFit NEX™ with Back D-Ring
- ▶ **If raising and lowering into a restricted space and no ladder is present:**  
3M™ DBI-SALA® ExoFit NEX™ with Back & Shoulder D-Rings
- ▶ **If work is being performed while suspended for a long period of time:**  
3M™ DBI-SALA® ExoFit NEX™ with Back & Front D-Rings and Seat Sling

3M™ DBI-SALA® ExoFit NEX™ Full-Body Harness Sizing Chart

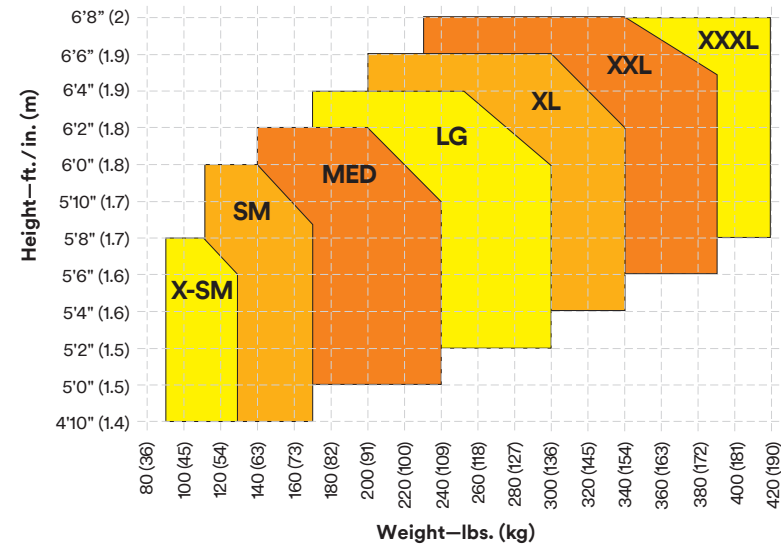

### Harnesses



1113040

1113010

1113070

1113193

Model # 1113030 1113031 1113034 1113037 1113040 1113043	3M™ DBI-SALA® ExoFit NEX™ with Back & Front D-Ring, XS Small Medium Large XL XXL
1113000 1113001 1113004 1113007 1113010 1113013	3M™ DBI-SALA® ExoFit NEX™ with Back D-Ring, XS Small Medium Large XL XXL
1113060 1113061 1113064 1113067 1113070 1113073	3M™ DBI-SALA® ExoFit NEX™ with Back & Shoulder D-Rings, XS Small Medium Large XL XXL
1113356 1113190 1113191 1113192 1113193 1113194	3M™ DBI-SALA® ExoFit NEX™ with Back & Front D-Rings & Seat Sling, XS Small Medium Large XL XXL

### Accessories



1001378

1001190

1001140

1001210

1231460

AK020A1

2108403

Model # 1001378	<b>Suspended Workman's Chair</b> Polyester webbing, alloy steel connectors, weight capacity of up to 420 lbs. (190.5 kg).
1001190	<b>Bosun Chair</b> 12" x 24" x 1" (30.5 cm x 61 cm x 2.5 cm) board, cushion and side snaps.
1001140	<b>Bosun Chair only</b> 12" x 24" x 1" board (30.5 cm x 61 cm x 2.5 cm).
1001210	<b>Retrieval Wristlets</b> Rescue/retrieval design is ideal for connection to victim's wrists for narrow extractions. Yoke wristlets attached to Y-lanyard with D-ring at end x 2' (61 cm).
1001220	<b>Retrieval Wristlets</b> Attached with an D-ring at one end x 18" (45.7 cm).
1231460	<b>Y-Lanyard</b> Rescue/retrieval design ideal for use with harness incorporating shoulder D-rings. Spreader bar with snap hooks at ends, D-ring at center x 2' (61 cm).
1231470	<b>Y-Lanyard</b> Y-Lanyard without spreader bar x 2' (61 cm).
AK020A1	<b>3M™ Protecta® Confined Space Pulley</b> Self-closing/locking carabiner fits up to 1/2" (1.3 cm) lifelines.
2108403	<b>Steel Spreader Hook</b> Self-closing/locking 3/4" (1.9 cm) opening.

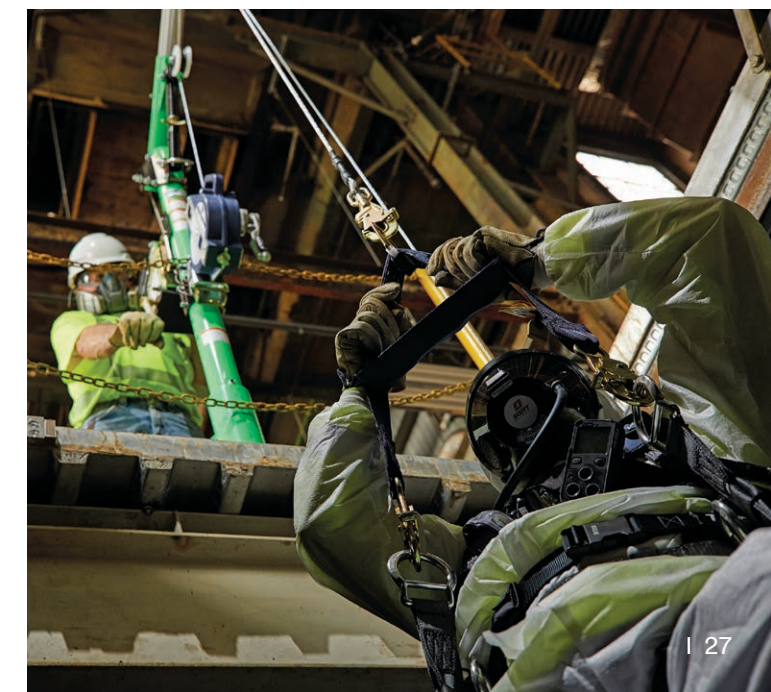

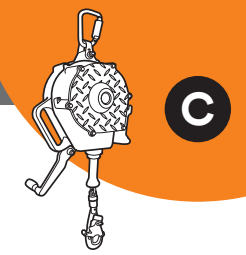

**Winches**

Used for | Raising and lowering personnel and equipment

**Retrieval SRL's**

Used for | Fall arrest  
Emergency rescue

**SRL's**

Used for | Fall arrest only

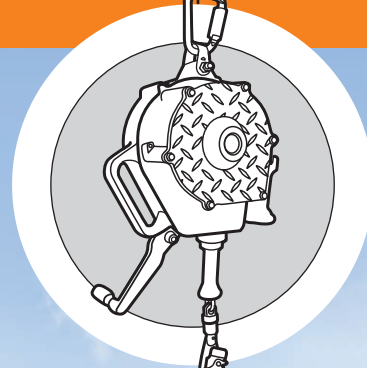

**Choosing a connector setup**

**Fall arrest/rescue only:**

Retrieval self-retracting lifeline is recommended where a ladder or other structure is present for ascending and descending the confined space.

**Entry/retrieval only:**

Use retrieval self-retracting lanyard or man-rated winch in spaces where no fall hazard is present.

**Fall arrest/rescue and entry/retrieval:**

Use retrieval self-retracting lifeline and winch in a space with a fall hazard and where no ladder is present for ascending or descending.

NOTE: For 3M's recommendation on the use of primary and secondary devices, please visit [3M.com/ConfinedSpace](http://3M.com/ConfinedSpace) for more information.

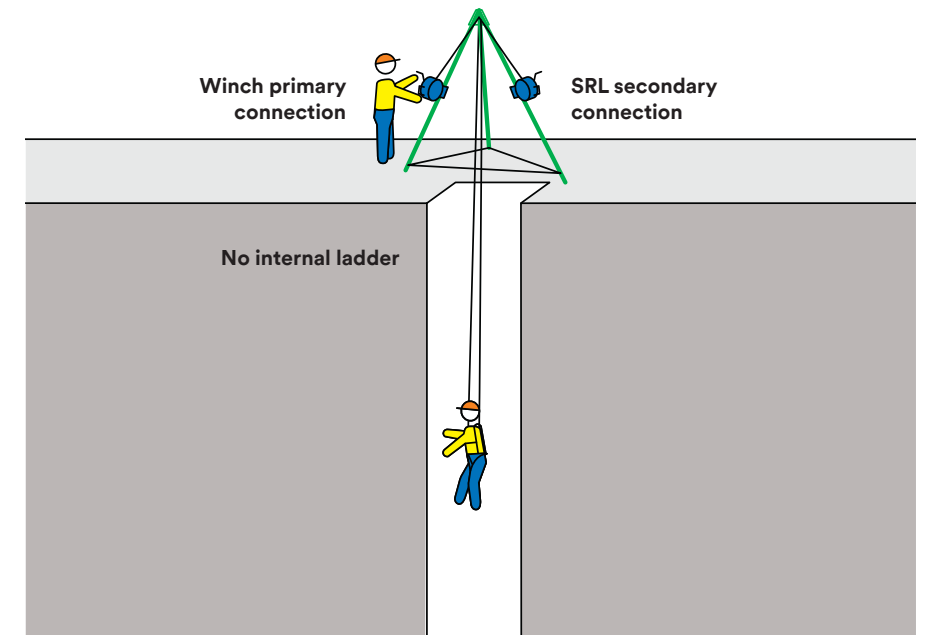
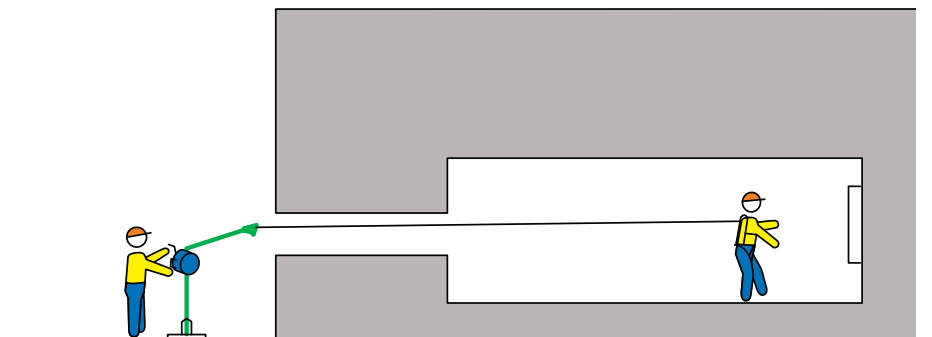
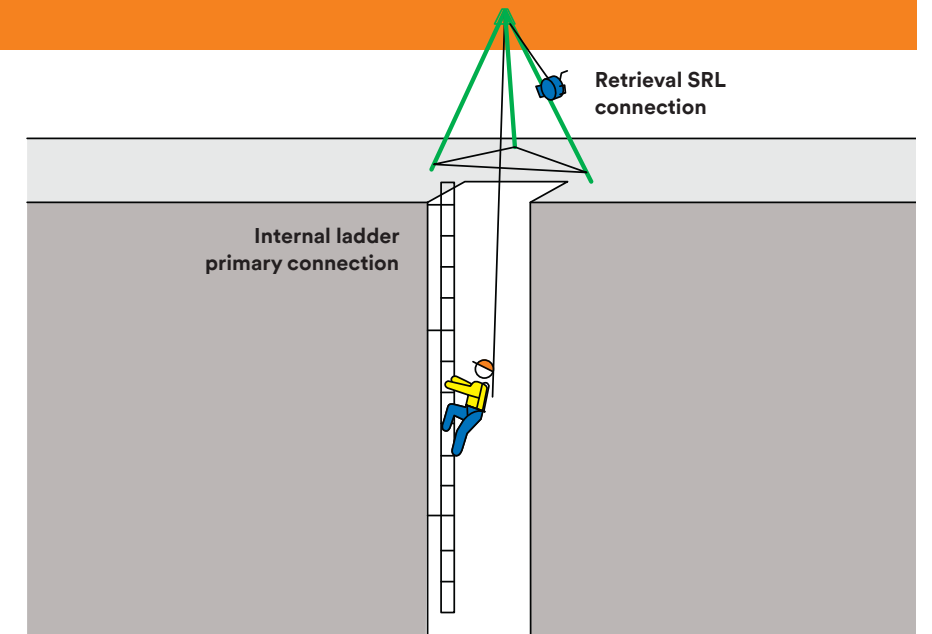

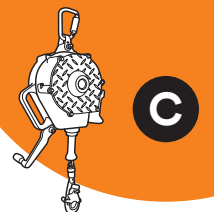

## Winches

Digital vs. 3M™ DBI-SALA® Salalift™ II									
	Maximum Capacity	Great Ratio(s)	Power Drive Capability	Maximum Lifeline Length	Carrying Bag Included	Freewheel Capability	Mounting Bracket Included	Cycle Count Indicator	Sealed Bearings
<b>Digital</b>	450 lbs. (204.1 kg)	Two speeds (4:1 & 9:1)	Yes	290 ft. (88.4 m)	No	No	Yes	Yes	Yes
<b>Salalift™ II</b>	350 lbs. (158.8 kg)	One speed (6:1)	No	120 ft. (36.6 m)	Yes	Yes	Yes	No	No

### Digital Winch

Drive Type	Lifeline Type	Mounting Bracket	60 ft. (18 m)	90 ft. (27 m)	140 ft. (42 m)	190 ft. (58 m)	240 ft. (73 m)	290 ft. (88 m)
Power drive*	Galvanized steel	■	8518567	8518568	8518588	8518589	8518610	8518611
	Stainless steel	■	8518565	8518566	8518586	8518587	8518608	8518609
	Technora® rope	■	8518571					
Removable handle	Galvanized steel	■	8518560	8518561	8518581	8518582	8518603	8518604
	Stainless steel	■	8518558	8518559	8518579	8518580	8518601	8518602
	Technora® rope	■	8518564					
	<b>Cable model weight</b>		30.5 lbs. (13.8 kg)	32.5 lbs. (14.7 kg)	40 lbs. (18.4 kg)	43 lbs. (19.5 kg)	50 lbs. (22.6 kg)	53.5 lbs. (19.5 kg)
	<b>Technora® rope model weight</b>		27 lbs. (12.2 kg)					



Power drive units require Overload Protection Clutch (8512936) — Not Included. Overload Protection Clutch used in conjunction with a drill for retrieving an entrant.

### Salalift™ II Winch

Drive Type	Lifeline Type	Mounting Bracket	Winch Bag	50 ft. (15.2 m)	60 ft. (18 m)	90 ft. (27 m)	120 ft. (36.5 m)
Removable handle	Galvanized steel	■	■		8102001	8102009	8102005
	Stainless steel	■	■		8102003	8102011	8102007
	Technora® rope	■	■	8102050			
	<b>Cable model weight</b>				30.5 lbs. (13.8 kg)	32.5 lbs. (14.7 kg)	38.5 lbs. (17.5 kg)
	<b>Technora® rope model weight</b>			27 lbs. (12.2 kg)			



## Accessories



<b>Model # 8517567</b>	<b>Digital Winch Carrying Bag</b>
<b>8512936</b>	<b>Overload Protection Clutch</b> Note: required for use with power drive digital winches.
<b>9507217</b>	<b>Salalift™ II Replacement Winch Bag</b> Note: all Salalift™ II winches come standard with a bag.

## Retrieval SRLs

3M™ DBI-SALA® Sealed-Blok™ Self-Retracting Lifelines with Retrieval incorporate a concept that separates all dynamic components, including the motor spring and break, from foreign elements such as grease, moisture and dirt. Constructed from heavy-duty, corrosion-resistant materials, the sealed design meets IP69K rating.



Retrieval Sealed-Blok™ SRL

Retrieval Sealed-Blok™ SRL - RSQ

3M™ DBI-SALA® Ultra-Lok™ Self-Retracting Lifelines with Retrieval are rugged, yet extremely lightweight and superbly engineered devices you can count on for safety, efficiency and comfort.



Retrieval Ultra-Lok™ SRL

- ▶ Available with RSQ Dual-Mode Design—allows users to select either standard fall arrest mode or automatic descent mode.
- ▶ Available lengths ranging from 30 ft (9.1m) to 175 ft (53.3m).
- ▶ IP69K Sealed Rating.

- ▶ Available in 50 ft length.

3M™ DBI-SALA® Sealed-Blok™ vs 3M™ DBI-SALA® Ultra-Lok™						
	Maximum Capacity	Maximum Lifeline Length	Lifeline Type			RSQ Available
			Technora® rope	Galvanized	Stainless steel	
<b>Sealed-Blok™</b>	420 lbs. (190.5 kg)	175 ft. (53.3 m)	■	■	■	■
<b>Ultra-Lok™</b>	310 lbs. (140.6 kg)	50 ft. (15.2 m)		■	■	

Cable Type	Sealed-Blok™	Sealed-Blok™ Without Bracket	Sealed-Blok™/ RSQ Without Bracket	Ultra-Lok™	30 ft. (9.1 m)	50 ft. (15.2 m)	55 ft. (16.8 m)	85 ft. (25.9 m)	130 ft. (39.6 m)	175 ft. (52.5 m)
Galvanized steel	■				3400853	3400923		3400871	3400976	
		■			3400850	3400920		3400870	3400975	3400660
			■			3400940		3400910		
Stainless steel				■		3501102				
	■				3400858	3400926		3400882	3400987	
		■			3400852	3400922		3400874	3400979	3400661
Technora® rope			■			3400942		3400912		
				■		3501103				
Technora® rope	■				3400840		3400843			

## Accessories



**Model # 3401025** **Mounting Bracket for Sealed-Blok™ Retrieval SRL**  
Fits all sizes of Sealed-Blok™ Retrieval SRL.



## Training Courses

We offer a variety of training and education courses to prepare employers and workers on proper use of safety equipment in confined spaces.

- ▶ On-site
- ▶ Classroom
- ▶ Online (digital/eLearning)

Part #	Course	Duration	Description
6480	Confined Space Entrant & Attendant	1 Day	This course addresses basic principles and concepts of confined space safety and the role of the attendant and entrant in the process. This course is ideally suited for those who will either enter or serve as an attendant for those entering basic confined spaces at the worksite.
6482	Confined Space Entry Supervisor & Program Manager	2 Days	Participants will learn principles required to safely identify, assess, monitor, and/or enter the confined spaces they may encounter on their job site. Participants for this course are all those who may be involved with a confined space program at the worksite.
6491	Confined Space Industrial Rescuer Level 1	1 Day	The Confined Space Industrial Rescuer Level 1 program will teach participants basic principles of confined space entry rescue using pre-engineered systems for both horizontal and vertical extrications for standard confined space applications within normalized atmospheres. The course will include a focus on the development and implementation of on-site rescue planning. The course prerequisite is attendance in our Confined Space Entrant & Attendant course and cannot be taken as a standalone course.
6493	Confined Space Industrial Rescuer Level 2	2 Days	The Confined Space Industrial Rescuer level 2 program will teach participants principles of confined space entry rescue using pre-engineered systems for both horizontal and vertical extrications into normalized or potentially hazardous atmospheres. The course will include rescue planning and development, as well as problem solving strategies and techniques for more complex spaces. The course prerequisite is attendance in our Confined Space Entry Supervisor & Program Manager course or equivalent type training.
7480	Certified Instructor Confined Space Entrant & Attendant	2 Days	The Confined Space Instructor will prepare participants for the delivery of our prescribed confined space safety curriculum designed for individuals serving as either attendants or entrants in basic confined space work environments. Participants successfully completing the course will be capable of delivering our established Confined Space Entrant & Attendant program. The course prerequisite is attendance in our Confined Space Entry Supervisor & Program Manager course.

For additional information on any of these programs, please contact our program coordinators at **800.328.6146** option 4 for training, or visit us at [3M.com/SafetyTraining](http://3M.com/SafetyTraining). In Canada, call **888.325.5776**.

## Additional Confined Space Entry PPE Solutions

### Supplied Air Solutions

Explore more at [3MScott.com](http://3MScott.com).



### Personal Protective Equipment

Explore more at [3M.com/PersonalSafety](http://3M.com/PersonalSafety).

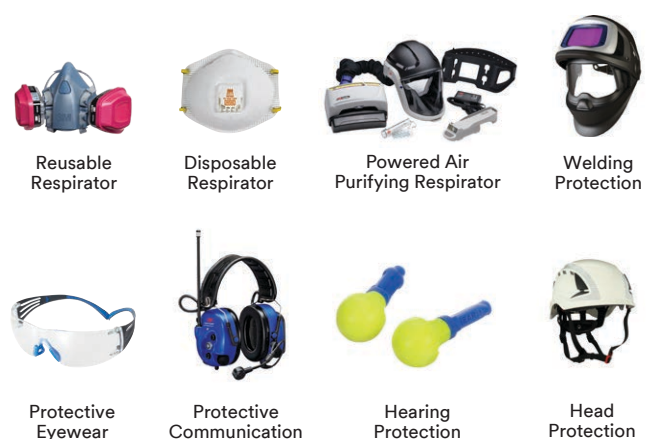

**3M Fall Protection**  
3833 SALA Way  
Red Wing, MN 55066 USA

Phone 800.328.6146  
Email [3mfallprotection@mmm.com](mailto:3mfallprotection@mmm.com)  
Web [3M.com/ConfinedSpace](http://3M.com/ConfinedSpace)

### [3M.com/ConfinedSpace](http://3M.com/ConfinedSpace)

3M, DBI-SALA, ExoFit NEX, Salalift, Sealed-Blok and Ultra-Lok are trademarks of 3M Company. All other trademarks are property of their respective owners. © 3M 2019. All rights reserved.  
Please recycle. Printed in USA. 70-0717-3955-4