



BOWMAN®



Dispersers

Organize • Contain • Comply

2020 e-Catalog



P P E D I S P E N S I N G S O L U T I O N S F O R E V E R Y M A R K E T

adaptable

TO ANY SETTING



Food Service



Business



Laboratory



Industrial



Healthcare



Dental



Construction



Education

All consumable items are for demonstration purposes only and are not available for purchase through BOWMAN®



find your solution

● Protection Systems..... 6	Specialty..... 46
Door & Glass Mounts 10	Designer Series..... 50
How to Choose Guide..... 12	● Face Mask Dispensers 52
4" Compliant..... 14	Cross Reference..... 54
Wall Mounts..... 16	● Bulk Dispensers 58
Semi-Recessed 18	● Specialty Dispensers 62
Mobile PPE Cart 20	Sterile Procedure Areas 62
Infection Prevention 24	Universal 64
● Cover Your Cough Compliance Kits & Hand Hygiene Dispensing Systems 26	Universal Cross Reference..... 65
How to Choose Guide..... 28	Healthcare 66
Cover Your Cough Compliance Kits 30	Bag, Cart Cover, BVM & CPR..... 68
Hand Hygiene Solutions..... 34	Cross Market 70
● Glove Box Dispensers 36	● Signature Series 72
Divided..... 38	● Build A Room..... 74
Non-Divided 42	● Construction & Renovation 76
Alternative 44	Semi-Recessed Dispensers..... 78
	● Index 84

catalog legend

Our goal is to make your life easier. You'll find just what you're looking for in a breeze with our easy to spot colorful icons throughout the catalog.

Look for Key Feature Icons

Key feature icons let you know about special product features that can help you choose the best product to fit your needs.



Online Tools & Product Videos



cross references

See if your box fits in our dispenser: BowmanDispensers.com/Product-Cross-Reference-Information



build a room

Plan and arrange dispensers using a photograph of your space: BuildARoomByBowman.com



product videos

Learn more and watch demonstration videos: BowmanDispensers.com/Product-Videos

- (ABS)** ABS Plastic 02
- (AFP)** ABS Fauxwood Plastic 02
- (ALM)** Aluminum 05
- (CRS)** Cold Rolled Steel 04
- (PET)** PETG Plastic 01

- (PLC)** Polycarbonate Plastic 12
- (STP)** Sintra® Plastic 07
- (STS)** Stainless Steel 03
- (WIR)** Powder-Coated Wire 06

material

- (●)** Bay Gray 29
- (●)** Black 20
- (●)** Cherry 33
- (●)** Maple 23
- (●)** Stainless Steel 00

- (○)** Clear 11
- (○)** Frosted Clear 14
- (○)** Quartz Beige 12
- (○)** White 13, 34

color

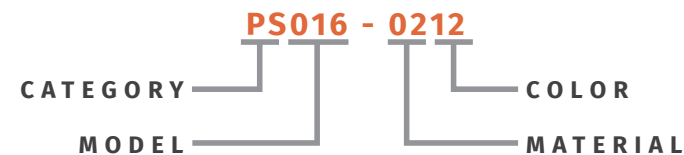

Example: **PS016-0212**
Protection System, Model 016, ABS, Quartz Beige

product number

Visit our website for extended material and color information. Colors may vary. Not all colors or materials are available for all dispensers. Use the material codes shown in this catalog as a reference for what a particular dispenser is made from. Custom options are also available.

why buy BOWMAN

BOWMAN Dispensers are proudly made in Arlington, Washington, USA

BowmanDispensers.com | 800-962-4660

- Quality materials and fabrication
- End user design collaboration
- Unique solution driven designs
- Good, better, and best cost options
- Organization that improves compliance
- Easy purchasing process
- Custom design abilities
- Family owned and operated



organize • contain • comply

It All Starts with a Little Card

Arm frontline staff with the tools necessary to isolate potentially infected patients upon arrival.

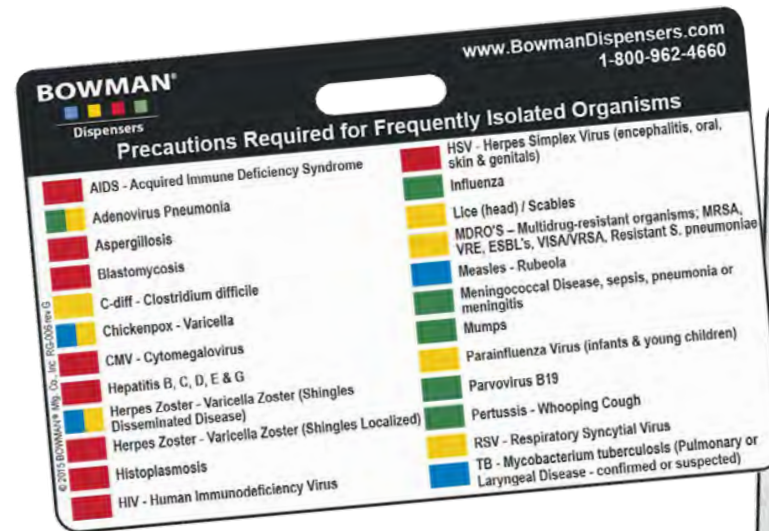

Transmission Based Precautions Quick Reference Guide*

Hand Hygiene Before & After Patient Contact *Ref. HICPAC/CDC Guidelines, 2007

	Standard	Contact	Droplet	Airborne
Clinical Situation	All patients	MDRO's - Resistant organisms; Diarrhea; Draining wounds	Upper Respiratory Infections; including unknown infections prior to organism ID	Tuberculosis - Pulmonary or Laryngeal Disease, confirmed or suspected; Chickenpox or Measles
Room Preference	Private or semi-private	Private. Consult Infection Control (IC) for co-horting	Private. Consult Infection Control (IC) for co-horting. Separate patients by 3 ft	Private. AllR negative airflow, door closed
Wear Gloves	Contact w/ blood, body fluids, or potentially contaminated material	Wear gloves upon entering room	Same as standard precautions	Same as standard precautions
Wear a Mask	Contact w/ blood, body fluids, or potential sprays of respiratory secretions	Same as standard precautions	Wear a mask upon entering room	Wear an N-95 mask or higher level respirator
Wear a Gown	Contact w/ blood, body fluids, or potentially contaminated material	Wear a gown upon entering room	Same as standard precautions	Same as standard precautions

RG-006

Transmission Based Precautions Quick Reference Card - Horizontal
Made of PVC Plastic

Also available as a vertical card - RG-008



1

Arm Staff with Isolation Reference Cards
RG-006

2

Identify Organism on Card and Match to Isolation Type

3

Print FREE Color-Coded Isolation Sign to Match Isolation Type

4

Place Sign in Clip-On Sign Holder

5

Place Sign Holder on Most BOWMAN Protection Systems

Information based on the Guideline for Isolation Precautions: Preventing Transmission of Infectious Agents in Healthcare Settings. Recommendations of the Healthcare Infection Control Practices Advisory Committee (HICPAC), CDC. <https://www.cdc.gov/infectioncontrol/pdf/guidelines/isolation-guidelines.pdf>

rethink

YOUR ISOLATION

BOWMAN has Protection System Solutions to fit any space, PPE volume & budget:

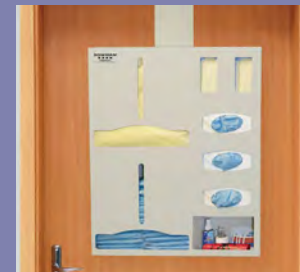

Over the Door



Wall Mount



Semi-Recessed



Mobile

easy, adaptable, beautiful & fast

Protection System Solutions from BOWMAN feature:

- Designs with direct input from healthcare professionals
- Highly visible & accessible PPE, allowing for easy restocking
- Universal sizing
- A variety of colors & configurations
- Small, medium & large dispensing capabilities
- Compatibility with BOWMAN Isolation Reference Cards & FREE printable signs to help prevent the spread of HAI's
- Made in the USA



easy

& ADAPTABLE

Protection Systems:

- Great for areas where hallway space constraints apply
- Portable or permanent mounting options available
- Standardize PPE location with wall mount units
- Visibility of supplies leads to increased PPE usage and compliance
- Quickly add isolation supplies during an outbreak with temporary door mounts
- Cost effective alternative to isolation carts

The Best Selling PS016 Protection System

Our proven design can be customized 125 different ways, mounts on doors or walls, and holds most major manufacturers' PPE products.



1 Variety of color & material offerings



PS016-0512
Aluminum



PS016-0223
Maple Fauxwood



PS016-0233
Cherry Fauxwood



PS016-0212
ABS Plastic

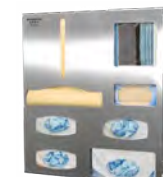

PS016-0300
Stainless Steel



PS016-0111
PETG Plastic

2 Sanitizer mounting area:

- Dial 54564
- Purell 1450-D8
- Steris 2121

3 Universal gown storage:

- Flat pack
- Reusable
- Overhead cover packs
- Thumb loop in boxes
- Thumb loop stacked

4 Adaptable storage area:

- 4th box of gloves
- Boxed face masks
- Miscellaneous supplies
- Surface wipes

Wall Mount & Over the Door Dispensing Options



Double Glove
LD-037 (ABS)

Also available - PS022-0512 (ALM)



Surgical
PS023-0212 (ABS)

Also available - PS023-0512 (ALM)



Double Mask
LD-070 (ABS)



Original
LD-007 (ABS)

Also available - PS021-0512 (ALM)

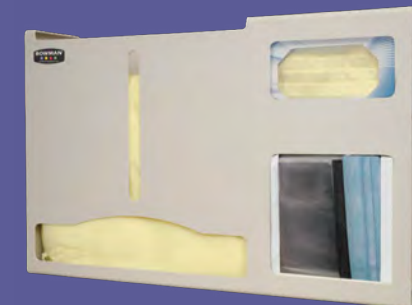

Gloveless
PS014-0212 (ABS)

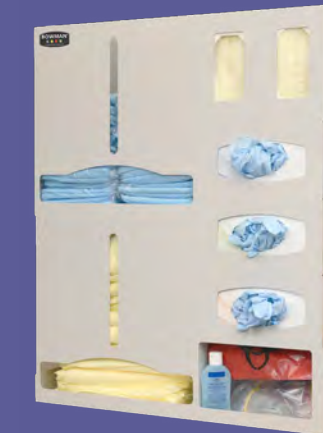

Double Gown
PS015-0212 (ABS)

Also available - PS015-0512 (ALM)



Compact
FM002-0212 (ABS)



Closed Door
PS001-0212 (ABS)



Many Protection Systems are now available bundled with a sign holder or with a sign holder and door hanger.

See pages 12-13 for details

door

MOUNT OPTIONS

Traditional Door Hanger



- Convert to an over the door solution by adding a hanger to a door, then adding any Protection System
- Easy to implement—just hang and start using
- Our most popular door hanger for standard sized doors
- Similar style to a wreath hanger
- Quick, cost effective solution, especially during an outbreak

top seller **MB-600** (CRS)
Hanger - Door

Also available:
MB-601 - for doors taller than 9 ft



learn more:
BowmanDispensers.com/
Product-Videos



Glass or Laminate Door Hanger



- Holds Protection Systems securely on glass or laminated wood using double sided semi-permanent VHB tape
- Wall hanger is rated for hanging BOWMAN branded product only

HH004-0412 (CRS) **new**
Hanger - Glass/Laminate

Metal Bracketed Door Hanger



MB-450 (CRS)
Hanger - Metal Bracketed Doors

- Double pronged solution
- Holds Protection Systems at adjustable heights to accommodate door hardware on fire doors

Clip-on Sign Holder



Free printable isolation signs available at BowmanDispensers.com



MP-047 (PET)
Sign Holder

Protection Systems How to Choose - Guide					
Product Description	Compact	Original	Double Glove	4" Deep	Double Mask
Part Number	FM002-0212	LD-007	LD-037	LD-064	LD-070
4" Deep: ADA Compliant					
Gown Style	Thumb Loop	Flat Pack, Reusable	All Styles	All Styles	Flat Pack, Reusable
Face Masks: Earloop	Single	Single	Single	Single	Single
Face Masks: Face Shield	Single <i>when no gowns are used</i>		Single		Single
Glove Box Options	Double	Triple	Double	Triple	Triple
Storage Areas				✓	
Alternative Color and Material		PS021-0512	PS022-0512		
Bundles					
System + Sign			BD638-0012	BD464-0012	
System + Sign + Hanger			BD637-0012		
System + Hanger		BD607-0012			BD670-0012

Protection Systems How to Choose - Guide					
Product Description	Closed Door	Gloveless	Double Gown	Most Versatile	Surgical
Part Number	PS001-0212	PS014-0212	PS015-0212	PS016-0212	PS023-0212
4" Deep: ADA Compliant			PS415-0212	PS412-0212	
Gown Style	All Styles	All Styles	All Styles	All Styles	
Face Masks: Earloop	Single	Single	Double	Single	Single
Face Masks: Face Shield	Single	Single		Single	
Glove Box Options	Double		Triple	Triple/Quad	Triple
Storage Areas			✓	✓	
Alternative Color and Material			PS015-0512 PS415-0512	PS016-0111 PS016-0223 PS016-0233 PS016-0512 PS016-0300 PS412-0512	PS023-0512
Bundles					
			BD415-0012 BD625-0012	BD412-0012 BD601-0012 BD601-0023 BD601-0033	
			BD615-0012	BD602-0012	

Guidance Standards for Accessible Design

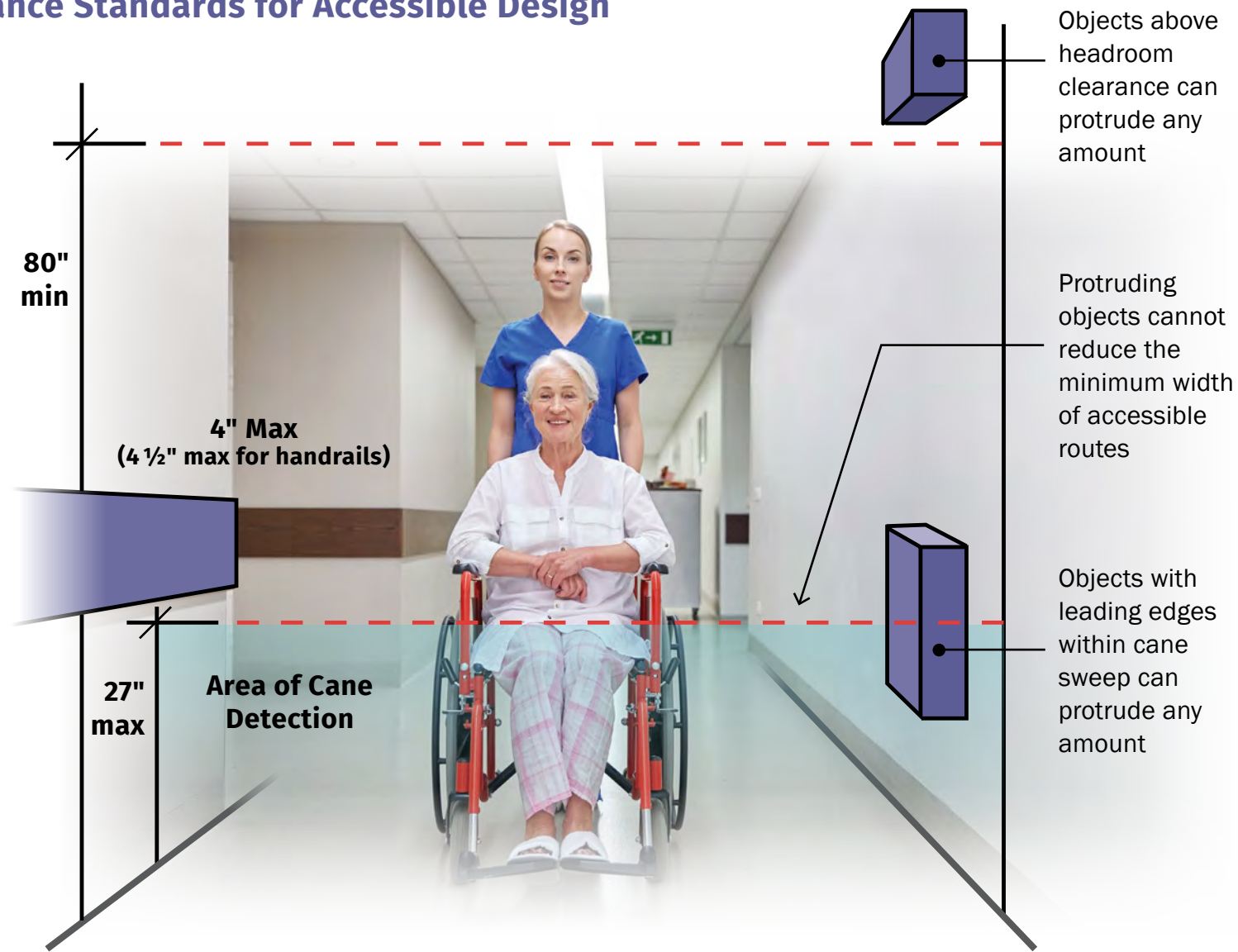

In 2016 the Centers for Medicare and Medicaid Services (CMS) began enforcing the guidelines set by the Americans with Disabilities Act (ADA) that limit the projection of objects into hallways. These standards protect the visually impaired from possible injury by objects mounted to the wall. BOWMAN offers a variety of products from Protection Systems to Glove Box Dispensers and everything in between that comply with the 4" depth guidelines.

Based on the ADA and Federal Register Guidelines: <https://www.ada.gov/regs2010/2010ADASTandards/Guidance2010ADASTandards.htm> & <https://www.federalregister.gov/documents/2016/05/04/2016-10043/medicare-and-medicaid-programs-fire-safety-requirements-for-certain-health-care-facilities#p-78>



comply INCH BY INCH



4" Protection System Solutions

- 4 inches deep to accommodate wall protrusion guidelines
- Adaptable to hang on a wall or over the door with a hanger
- Quickly converts to an isolation unit with our free isolation signs from BowmanDispensers.com
- Fits most standard size glove boxes and gowns; due to depth, face masks may need to be removed from box
- Semi-Recessed dispensers are also 4" compliant, see pages 78-83
- Many 4" units are available as bundles, see pages 12-13 for details



Double Gown

PS415-0212 (ABS)

4" Wall Extension

Also available - PS415-0512 (ALM)



Quad Glove

PS412-0212 (ABS)

4" Wall Extension

Also available - PS412-0512 (ALM)



Triple Glove

LD-064 (ABS)

4" Wall Extension Narrow



Gloveless

PS426-0212 (ABS)

4" Wall Extension Narrow

safety

AT ALL TIMES

Place a Wall Mount Protection System outside of each patient room for protection against blood borne pathogens.



learn more:
BowmanDispensers.com/
Product-Videos



isolation

IN A HEARTBEAT

Quickly convert to an Isolation Station by clipping on a Sign Holder.

MP-047 Sign Holders sold separately; free isolation signs are available at BowmanDispensers.com



See our bundles on pages 12 & 13



Bundle includes Protection System & Sign Holder



wall

MOUNT OPTIONS

Wall Mount Hanger

- Makes isolation easy by permanently mounting a wall hanger outside of each patient room
- When isolation is needed, just hang the Protection System onto the small metal bracket and the room is ready



MB-510 CRS
Hanger - Wall



Direct-to-Wall with Keyholes

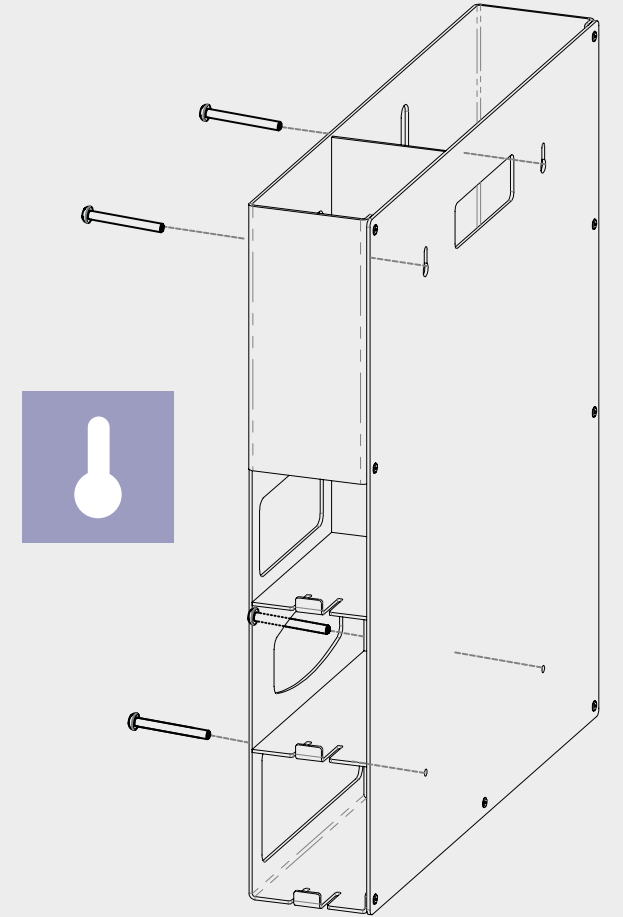

- Permanently mount Protection Systems using keyholes on back, with customer supplied hardware
- Increases compliance by ensuring PPE is consistently available to staff outside of each patient room

BEAUTIFULLY
compliant
EXCLUSIVELY
BOWMAN



PATENT: www.BowmanDispensers.com/patents

Semi-Recessed Protection Systems



RE101-0012

Protection System - Standard
24.36"W x 27.65"H x 4.77"D

Shown with optional MP-047
Pg 18: Partial Open View

Also available - Solid Door
RE103-0012
See page 80 for details



BACKED BY OUR

15 YEAR

WARRANTY

Semi-Recessed Protection Systems are a smart choice for high traffic areas, such as hallways or near elevators. Our in-wall solutions avoid wall protrusion rule concerns while keeping necessities organized and at hand.

FEATURING:

- ADA compliance benefit; once installed protrusion is approximately 1 ¼"
- Simplifies supply location standardization
- Visible access to supplies improves PPE donning compliance and restocking
- Universally sized to hold most major brands of PPE consumables
- Improves HCAHPS scores with a sleek, organized, and aesthetically pleasing design
- One in-wall well, adjustable shelves, and interchangeable doors
- Additional layouts and custom designs available
- Made in the USA out of Quartz Beige Powder-Coated Steel
- For additional Semi-Recessed Dispensers see pages 78-83

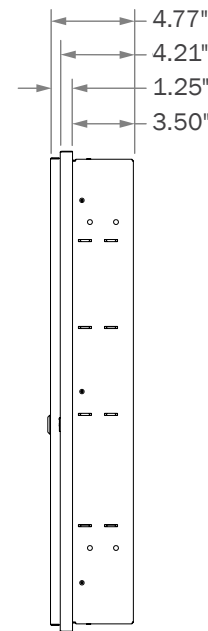

**Center Side View
Installation Specs for all
Semi-Recessed Units**

- 4.77" - Overall depth to face of door
- 4.21" - Overall depth to front of frame
- 1.25" - Depth of installed wall protrusion
- 3.50" - Semi-Recessed depth

Measurements shown are overall external dimensions. For complete details on measurements and specifications, download product datasheets at BowmanDispensers.com

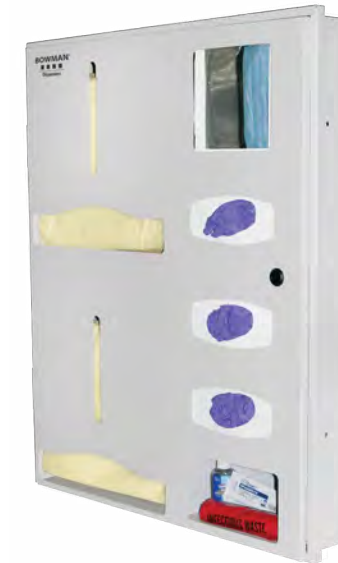

RE201-0012

Protection System - Double Gown
27.38"W x 33.33"H x 4.77"D



RE202-0012

Protection System - Reusable Gown
27.38"W x 33.33"H x 4.77"D

All consumable items are for demonstration purposes only and are not available for purchase through BOWMAN®



semi-recessed video:
[BowmanDispensers.com/
Product-Videos](http://BowmanDispensers.com/Product-Videos)

ppe supplies

WHEN & WHERE
YOU NEED THEM

THINK
OUTSIDE
THE BOX

Personal Protective Equipment supplies are not just for patient isolation. PPE is there to protect staff from hazardous materials and drugs in addition to infectious organisms and blood borne pathogens. Keep your protection equipment available so staff remain compliant with the most adaptable cart for any patient care area.

- Burn Units
- Emergency Department
- Post Anesthesia Recovery
- General Medical Floors
- Interventional Radiology
- GI Labs
- Intensive Care & Oncology: Transmission Based Precautions and USP 800 Compliance
- USP 800 Compliance: Pharmacy



CT030-0000    

Mobile Protection System - PPE Cart II
Shown with optional
MP-047 sign holder

Accessible & Adaptable

- Instant access to PPE
- Standing dispensing, NO bending or searching
- Universal PPE sizing adapts to frequently changing consumable supplier contracts

Efficient & Cost Effective

- PPE is visible in the front and top.
- Glove size indicators for quick grab & go
- Holds all styles of gowns: reusable, flat pack, or thumb loop
- Earloop and/or face shield masks area
- Additional storage area for restock and alternative USP 800 supplies

Safety

- Back safety protection using BOWMAN's exclusive "Standing Dispensing PPE Layout"
- Lightweight, easy roll casters, and toe locking brake
- Exceeds UL industry requirements for tipping stability: California Phase 2 Compliant

Compliance

- Yellow isolation color for easy precaution identification
- Clip-on isolation ID sign holder available
- Industry first: donning process indicators
- Dual purpose handle for hanging personal items to decrease cross contamination

Emergency
Departments



Mobile PPE Cart | 21

Medical Units



PAR



adaptability

SOLUTIONS FOR EVERY MARKET

Comply with OSHA, NIOSH, U.S. Pharmacopeial Convention (USP 800), and other regulatory agencies by having the appropriate Personal Protective Equipment (PPE) available to protect staff.



PHARMA/CLEAN ROOM/LAB

These specialized markets may require additional unique PPE protection. In addition to the traditional gloves, face masks, and gown dispensing areas on the top of the cart, the closed lower storage area on our PPE Cart is adaptable to a variety of industry specific PPE requirements.

AGRICULTURE MARKET

Easily transition from the fields to indoor sorting with our large volume glove and other PPE supplies by utilizing our unique dispensing Cart.

INDUSTRIAL MANUFACTURING

5S your lean manufacturing processes by avoiding wasted trips back and forth to your job box for PPE. Our PPE Cart allows you to flex and move supplies where they are needed in your manufacturing lines while keeping them clean.

FOOD PROCESSING PLANT

We understand that in food processing, a more comprehensive selection of PPE may be required. The storage area and dispensing versatility in BOWMAN's PPE Cart allows for full body coverage PPE dispensing. Additional items like bouffant caps, shoe and boot covers, aprons, sleeves, beard restraints, and more!



don't TRANSPORT your INFECTIOUS ORGANISMS!

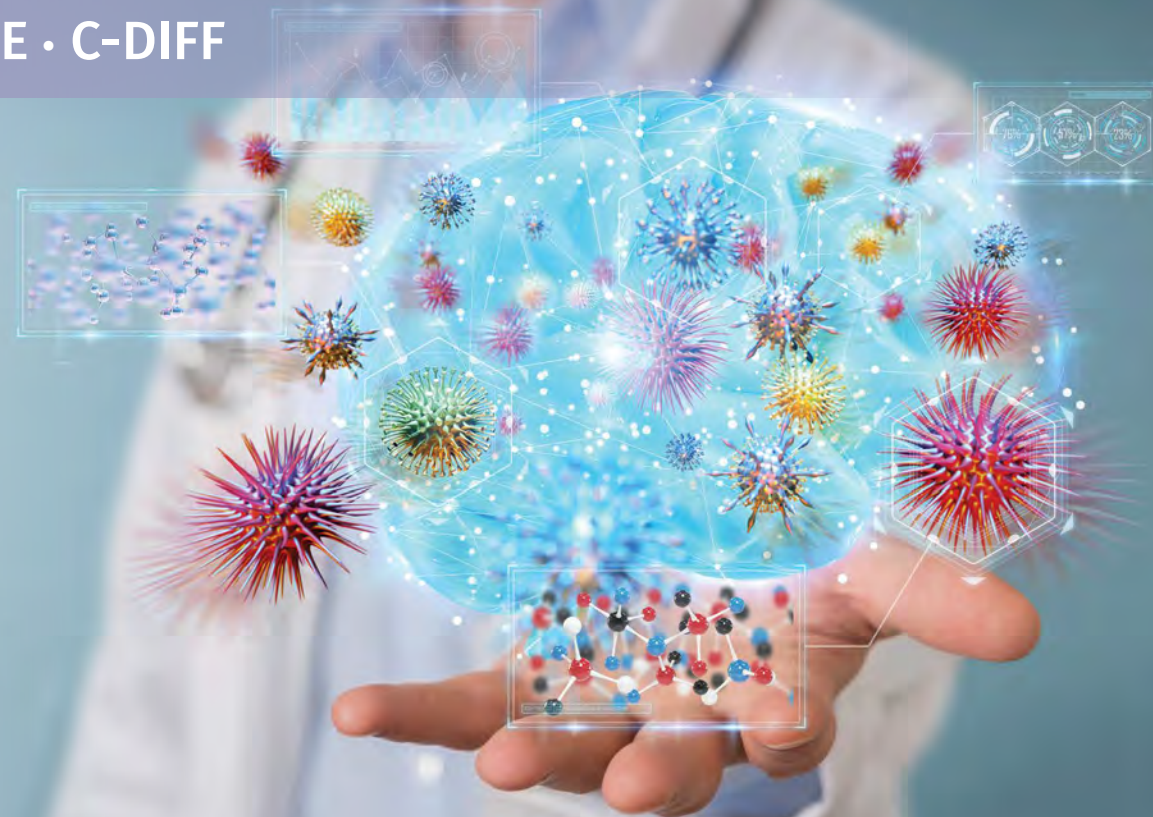

Help decrease Healthcare-Associated Infections (HAI's) by utilizing BOWMAN Infection Prevention Stations at critical point of care areas.

Protecting patients, visitors, and staff from microorganisms that spread by contact with contaminated surfaces, staff and common use items can vary in different departments and areas. BOWMAN has a variety of interchangeable solutions to meet each specific need.

Use stations on a counter, wall, or floor stand near:

- Clinics
- Nursing Stations
- Exam Rooms
- Office Environments
- Lab Areas
- Dialysis Centers
- Schools/Classrooms
- Transportation Services

FD-068 (ABS)
Infection Prevention System



KS010-0412 (CRS)
Floor Stand
KS201-0029
Floor Stand
also available

Standardize location of supplies to ensure compliance with Infection Control policies - Use RS001-0212, ED-097 or FD-068 for separation of clean and dirty areas.

1) Select Layout



RS001-0212 (ABS)
Respiratory Hygiene Station



ED-097 (ABS) (PET)
Infection Prevention System
MP-075 Sign Holder included



FD-068 (ABS)
Infection Prevention System



2) Identify Base Style



KS010-0412 (CRS)



KS201-0029* (CRS)

Customizable solutions to meet unique dispensing needs



 **learn more:**
BowmanDispensers.com/
Product-Videos

*IMPORTED

cover your cough

COMPLIANCE KITS

Guard against the unknown with Respiratory Hygiene Solutions from BOWMAN:

- Convenient access to PPE
- Standardized dispensing location
- Supports best practice adherence
- Enhances patient, staff, and visitor safety
- Drives refill compliance
- Contains costs by preventing Hospital Associated Infections (HAI's) and outbreak investigations



TAKE PRECAUTIONS TO
prevent
THE SPREAD OF INFECTION



Comply with the 4-step CDC Guidelines:

- 1 Visual Alerts**
Post visual alerts at the entrances of healthcare facilities, including emergency departments, physician offices, clinics, etc.
- 2 Cleaning Hands**
Use of antiseptic hand wash if a sink for hand washing is not available.
- 3 Wearing Face Masks**
Wear a mask if coughing. Masks available for visitor use.
- 4 Using Tissues**
Cover the nose and mouth with a tissue when coughing or sneezing and properly dispose of tissues after use.



Download Free multilingual Cover Your Cough Signs at BowmanDispensers.com



Based on the CDC's Respiratory Hygiene/Cough Etiquette in Healthcare Settings Guidelines: <http://www.cdc.gov/flu/professionals/infectioncontrol/resphygiene.htm>
All consumable items are for demonstration purposes only and are not available for purchase through BOWMAN®



CYC compliance kits video:
BowmanDispensers.com/Product-Videos

Cover Your Cough Compliance Kits Guide

1

Determine Layout
BASED ON HAND SANITIZER



2

Choose Security Level
LOCKING LID OR NO LID



3

Select Color & Material
PLASTIC OR STEEL



QUARTZ BEIGE
ABS PLASTIC

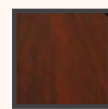

CHERRY
ABS FAUXWOOD PLASTIC



MAPLE
ABS FAUXWOOD PLASTIC



QUARTZ BEIGE
STEEL

HOW TO CHOOSE YOUR CUSTOM STATION

4

Pick Sign Direction
VERTICAL OR HORIZONTAL

VERTICAL



HORIZONTAL



5

Identify Location for Dispensing
COUNTER/WALL OR FREESTANDING

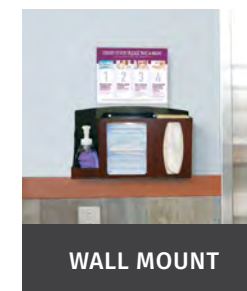
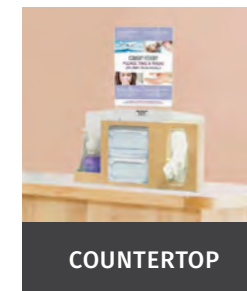

6

Review Options
SEE PAGES 30-33 FOR EXAMPLES



protect

YOUR PATIENTS, YOURSELF
& YOUR FAMILY

Have PPE in sight when and where you need it. Place a Cover Your Cough Compliance Kit on a countertop in your front office, or mount it on a wall near the elevator. Perfect for any public area.

Countertop & Wall Mount

AUTOMATIC PUMP OR FOAM SANITIZER

BD216-0012 (ABS) (Lock)

Quartz Beige

Station: ABS Plastic
Sign: PETG Plastic

Other options:

BD206-0012 (CRS) (Lock)

BD214-0012 (ABS)



Hand sanitizers not included

Countertop & Wall Mount

TISSUE & FACE MASKS

BD322-0012 (ABS) (Lock)

Quartz Beige

Station: ABS Plastic
Sign: PETG Plastic



Countertop & Wall Mount

BOTTLED SANITIZER OR WIPES

BD211-0012 (ABS)

Quartz Beige

Station: ABS Plastic
Sign: PETG Plastic

Other options:

BD201-0012 (CRS)

BD211-0023 (AFP)

BD211-0033 (AFP)



Countertop & Wall Mount

LOCKING BOTTLE AREA

BD262-0012 (ABS) (Lock)

Quartz Beige

Station: ABS Plastic
Sign: PETG Plastic
Lid: PETG Plastic



Clinics

PHYSICIANS' OFFICES

EMERGENCY DEPARTMENT WAITING ROOM

All Ports of Entry

OUTPATIENT CHEMOTHERAPY CLINICS

Interventional Radiology

Admitting



take a stand

AGAINST THE SPREAD OF INFECTION

Freestanding Cover Your Cough Compliance Kits offer infection control supplies to be in the right place at the right time. Keep them near entryways and in public waiting areas so infection control is always top of mind.



CYC compliance kits video:
BowmanDispensers.com/
Product-Videos

Freestanding AUTOMATIC PUMP OR FOAM SANITIZER



BD116-0012 (ABS) (Lock)

Quartz Beige
Station: ABS
Stand: Steel
Sign: PETG Plastic

Other station options:

- BD106-0012 (GRS) (Lock)
- BD114-0012 (ABS) (Lock)
- BD116-0023 (AFP) (Lock)
- BD116-0033 (AFP) (Lock)

Hand sanitizers not included



Freestanding BOTTLED SANITIZER OR WIPES

BD111-0012 (ABS)

Quartz Beige
Station: ABS Plastic
Stand: Steel
Sign: PETG Plastic

Other station options:

- BD101-0012 (GRS) (Lock)
- BD111-0023 (AFP) (Lock)
- BD111-0033 (AFP) (Lock)
- BD162-0012 (ABS) (Lock)

All consumable items are for demonstration purposes only and are not available for purchase through BOWMAN®

hand hygiene is the #1 way

TO PREVENT THE SPREAD OF INFECTION



Hand Hygiene Dispensing System



KS101-0029*  
Hand Sanitizer Floor Stand
Floor Stand & Dispenser Back Plate
Accommodates most major manufacturers' hand sanitizer, hand lotion, and foam dispensers

*Hand sanitizers not included | *IMPORTED*
All consumable items are for demonstration purposes only and are not available for purchase through BOWMAN®



protection for any setting



ADA Compliant Semi-Recessed Hand Hygiene Dispensing System

RE304-0012  
Hand Sanitizer Station
12.35"W x 18.85"H x 4.22"D

- Universal wall well for housing hand sanitizer dispensers
- Embossed drip tray designed to contain over dispensing
- Accommodates most front loading hand sanitizer manufacturers' dispensers (required dispensing clearance) less than: 11.30"W x 17.94"H x 5.00"D

SN304-0713  
Sign - Hand Sanitizer Station
6.30"W x 6.00"H x 3.71"D

- Optional 3D sign
- "V" shape projects from the wall allowing for easy visualization from front and sides

PATENT: www.BowmanDispensers.com/patents



 **CYC compliance kits video:**
BowmanDispensers.com/Product-Videos



PERFECT FIT
universal appeal

Glove box dispensing solutions from BOWMAN fit any industry and organizational need:

- Material options for any budget
- Different finishes for any interior
- Top, right, and left loading options
- Vertical and horizontal mounting choices
- Single, double, triple, and quad layouts
- Minimal to full glove box visibility
- Changing suppliers means you can keep using the same dispensers, as BOWMAN accommodates most brands



versatile

MOUNTING OPTIONS

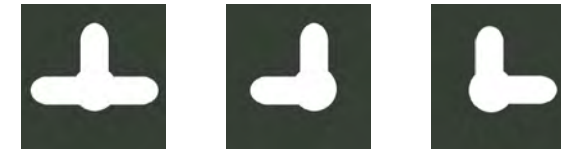

Versatile mounting keyholes allow Glove Box Dispensers to be permanently mounted in the direction of your choice:

- Choose horizontal or vertical mount based on loading preference or space availability
- Use hardware recommended by building or maintenance staff

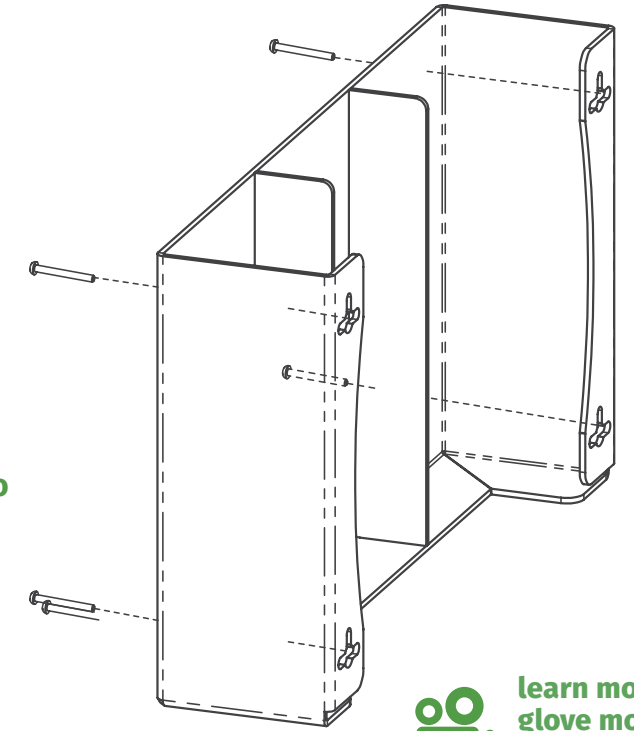

learn more about glove mounting options:
BowmanDispensers.com/Product-Videos



→ Left Load



↓ Top Load



Right Load ←

easy

RESTOCK

Divided Glove Box Dispensers allow quick replacement of empty boxes without disrupting the whole unit.



Divided Glove Box Dispensers

ABS Fauxwood Plastic - Cherry (AFP)



GL010-0233
Single



GL020-0233
Double



GL030-0233
Triple



GL040-0233
Quad

ABS Fauxwood Plastic - Maple (AFP)



GL020-0223
Double



GL010-0223
Single



GL030-0223
Triple



GL040-0223
Quad

Divided Glove Box Dispensers

Powder-Coated Steel - White (CRS)



GL003-0413
Triple



GB-001
Single



GL002-0413
Double



GL004-0413
Quad

Stainless Steel (STS)



GS-124
Quad



GS-004
Single



GS-122
Double

top seller



GS-123
Triple

top seller

Divided Glove Box Dispensers

Clear PETG (PET) & Polycarbonate Plastic (PLC)



GL300-1214 (PLC)
Triple

top seller



GL100-1214 (PLC)
Single

top seller



GL020-0111 (PET)
Double



GL040-0111 (PET)
Quad

ABS Plastic - Quartz Beige (ABS)



GL300-0212
Triple

top seller



GL100-0212
Single



GL020-0212
Double



GL040-0212
Quad

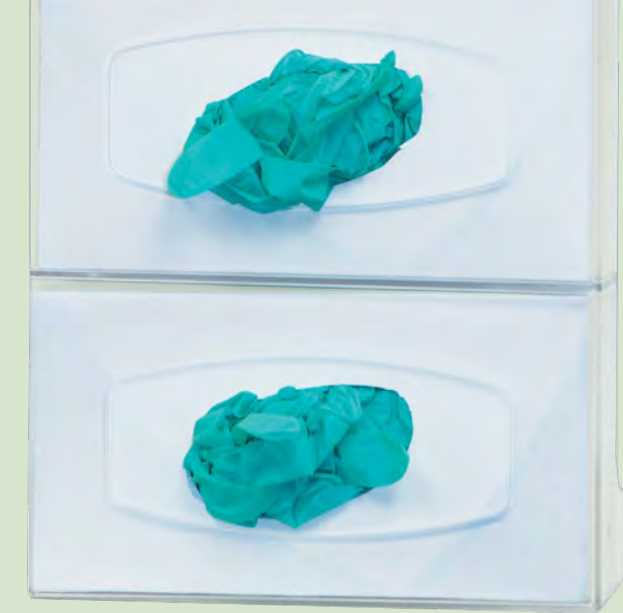

strong

WE'RE NOT AFRAID TO
SHOW YOU WHAT WE'RE MADE OF

High quality BOWMAN Glove Box Dispensers are manufactured with materials that work in extreme environments and can withstand frequent use of harsh cleaning agents—without weakening or discoloring.

 learn more about quality plastics:
BowmanDispensers.com/Product-Videos

PETG

- Extreme clarity and light transmission
- High gloss surface finish
- Can bend, twist, and endure most impacts without breaking

ABS

- Strong & flexible
- Opaque
- Used to manufacture products such as camera bodies and power tools

POLYCARB (shown above)

- Naturally transparent thermoplastic
- High impact strength
- Used to manufacture products such as eyeglass lenses & bullet-proof glass

cost effective solutions

NON-DIVIDED GLOVE BOX DISPENSERS

Non-Divided Glove Box Dispensers

Clear PETG Plastic (PET)

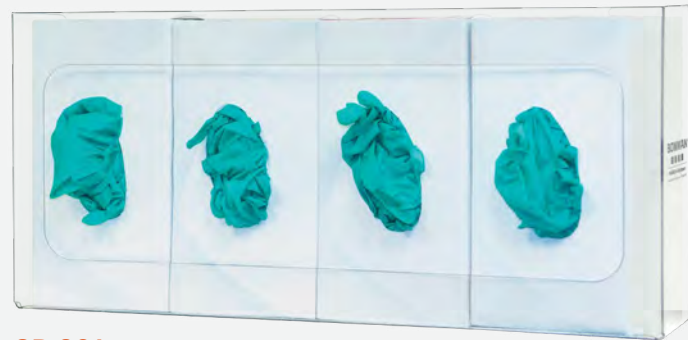

top seller

GP-061
Quad



GP-013
Single

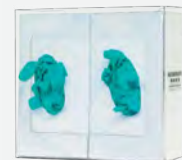

GP-014
Double



GP-015
Triple

top seller

Coated Wire - White (WIR)

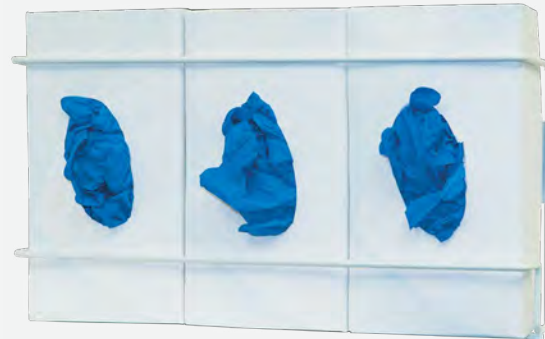

top seller

GL033-0613*
Triple



GL011-0613*
Single

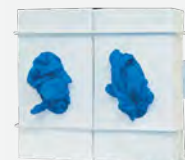

GL022-0613*
Double

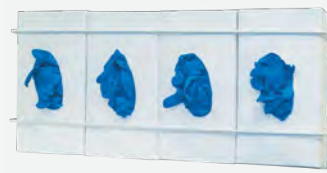

GL044-0613*
Quad

*IMPORTED

Non-Divided Glove Box Dispensers

Powder-Coated Steel - White (CRS)



GB-002
Double



GB-001
Single



GB-003
Triple

top seller

GB-059
Quad



Stainless Steel (STS)



GS-004
Single



GS-005
Double



GS-006
Triple

top seller

GS-060
Quad



top seller

All consumable items are for demonstration purposes only and are not available for purchase through BOWMAN®

alternative options

Unique box size or space restrictions for dispensing?
BOWMAN offers more than your standard Glove Box Dispenser configuration to fit any space.



GL016-0111 (PET) 
Extra Long - Single

Extra Long



GL036-0111 (PET) 
Extra Long - Triple

Vertical or Horizontal Space Saver TOP LOADING



GP-107 (PET)
Triple - Space Saver
Also available:
Double - GP-106



GB-068 (CRS)
Triple - Space Saver
Also available:
Double - GB-067



GS-109 (STS)
Triple - Space Saver
Also available:
Double - GS-108



Shown: Two GS-108's stacked for side loading in tight spaces

Vertical Top Loading CLEAR PETG PLASTIC



GP-310 (PET)
Single - Top Load



GP-320 (PET)
Double - Top Load



GP-330 (PET)
Triple - Top Load

Also available - Stainless Steel
GL018-0300 (STS) 



GP-340 (PET)
Quad - Top Load

compatible

BOWMAN Glove Box Dispensers come in a myriad of sizing and color options to integrate seamlessly into any environment. Whether you need a standard place to store a few boxes of gloves, or have many rooms and varieties of gloves to organize, BOWMAN has your perfect fit.



learn more about
space saving options:
[BowmanDispensers.com/
Product-Videos](http://BowmanDispensers.com/Product-Videos)

Top Loading and Space Saver Glove Box Dispensers are loaded from the top only and therefore require that all glove boxes be removed to replace the bottom box.

All consumable items are for demonstration purposes only and are not available for purchase through BOWMAN®

**Extra Narrow
FOOD SERVICE**



GL102-0300 (STS)
Single - Extra Narrow
Also available -
Clear PETG Plastic GL102-0111 (PET)

cross reference: online

**Narrow
STANDARD**



GP-073 (PET)
Triple - Narrow
Also available - Single - GP-071 (PET)
Double - GP-072 (PET)

**Large Capacity
STANDARD**



GS-073 (STS)
Single - Large Capacity
Also available -
Clear PETG Plastic GP-020 (PET)
White Powder-Coated Steel GB-074 (CRS)

adaptable

In any market where PPE is required, BOWMAN Dispensers are here to keep you organized!

- Healthcare
- Industrial Manufacturing
- Lab/Cleanroom
- Pharmacy
- Food Processing
- Dental
- Animal Health
- Education



Cart Options

Upgrade your current med, dialysis, crash-cart, or any cart by mounting or hanging a Glove Box Dispenser to the unit.



GL136-0412 (CRS)
Cart Attachment - Triple



GL134-0412 (CRS)
Cart Clip-On - Single

All consumable items are for demonstration purposes only and are not available for purchase through BOWMAN®

Specialty



GC-009 (STP)
Bulk



PS004-0212 (ABS)
Triple Glove & Single Bag
Also available
PS004-0111 (PET)



GL143-0111 (PET)
Also available
GL143-0212 (ABS)



GL018-0300 (STS)
Also available
GP-330 (PET)



Interior Cabinet

- A great option for locations where a built-in look is preferred
- Frees up space on countertops and walls, while allowing easy access to essentials
- Available for select BOWMAN Dispensers and custom designed products



GB-144 (CRS)
Single
Unmounted View



GL300-1214 (PLC)
Triple with Dividers
Top: Inside pre-cut cabinet
Left: In use inside dental office
(Photo provided by Cabinet Plus, Inc.)

Semi-Recessed



- One in-wall well with adjustable shelving
- Quarter-turn lock to secure door
- Optional glove size indicator
- Innovative and aesthetically pleasing design



RE301-0012 (CRS)
Triple
12.34"W
18.83"H
4.77"D



RE404-0012 (CRS)
Quad
12.34"W
24.48"H
4.77"D



RE401-0012 (CRS)
Triple with Earloop
Face Mask Dispenser
12.34"W
24.48"H
4.77"D

PATENT: www.BowmanDispensers.com/patents

Overall external dimensions. For side view installation specs, see page 78.

large volume

DISPENSING NEEDS



6 Box Dispensing = 2 Triple Dispensers
8 Box Dispensing = 2 Quad Dispensers

before



Dispenser is too small for actual needs. Boxes are stacked and disorganized.

after



Maximize storage and keep a clean working space with more capacity.

GL003-0413 (CRS)
Triple with Dividers
Shown: 2 for sextuple dispensing



learn more about
dispensing options:
[BowmanDispensers.com/
Product-Videos](http://BowmanDispensers.com/Product-Videos)

uniquely yours

DESIGNER GLOVE BOX DISPENSERS BY BOWMAN



BOWMAN's new Designer Glove Box Dispenser Line allows you to customize your dispenser to match your environment. Draw attention to your dispensers or minimize them by using color and patterns to blend in or stand out. Whatever you decide, BOWMAN has a solution that will meet your needs.

STEPS TO ORDER DESIGNER SERIES DISPENSERS

- 1 Select Glove Box Dispenser configuration
- 2 Choose your pattern
- 3 Contact our sales team to order

Minimum quantity orders of 24 units are required

1 select your configuration

4 layout options available in durable PETG plastic



learn more about quality plastics:
BowmanDispensers.com/
Product-Videos

CONFIGURATION & PATTERN KEY



2 choose your pattern

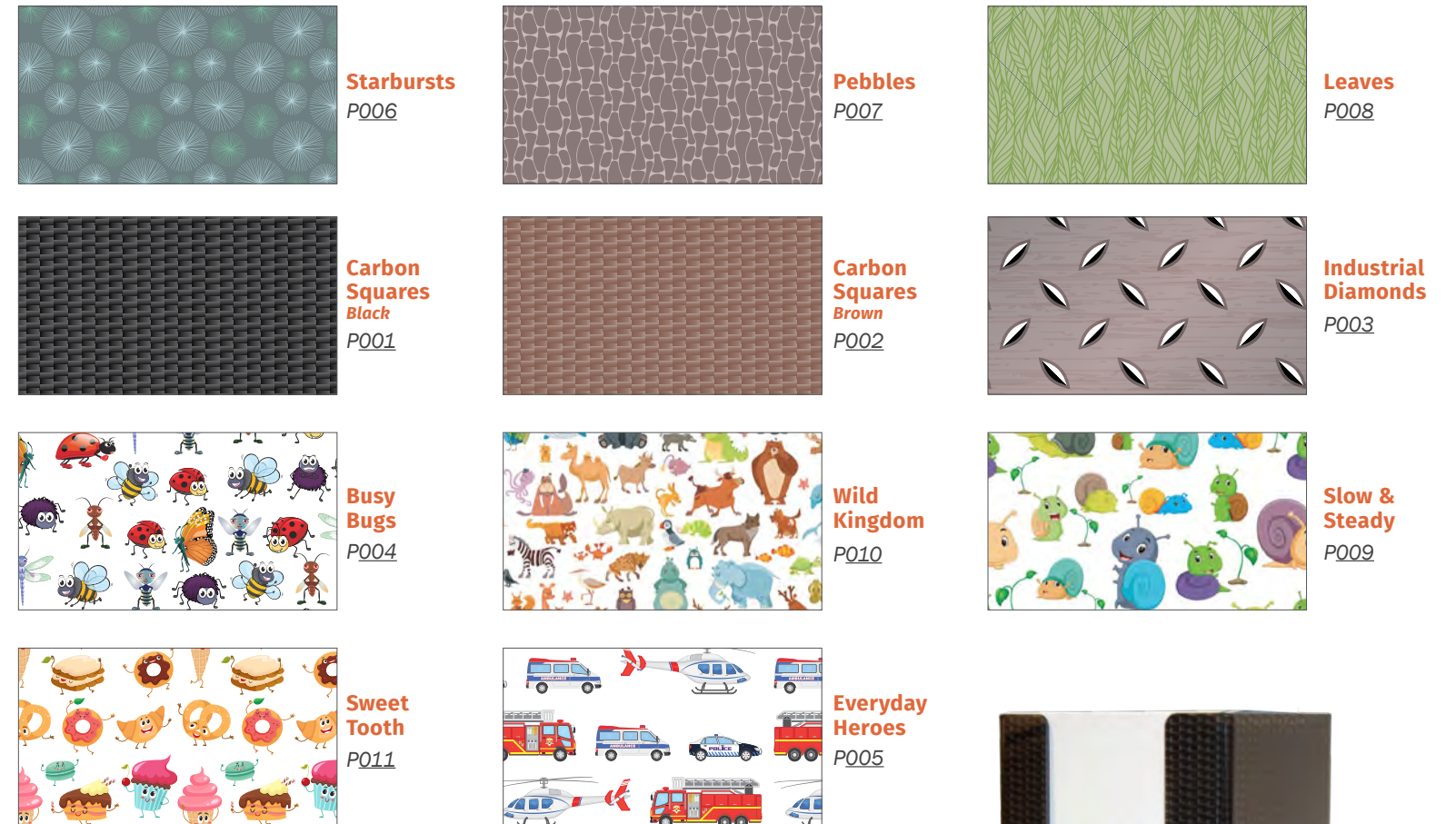

3 ready to order?

- ✓ Standard Designs: Model number, pattern number, and quantity required have been determined.
- ✓ Custom Designs: Interested in using your own design?

Contact our sales team: sales@bowmandispensers.com





dispensing smiles

ACROSS EVERY INDUSTRY

Determine which BOWMAN Face Mask Dispenser fits your style and brand of face masks:

cross reference:
pgs 54-57 & online

learn more about quality plastics:
BowmanDispensers.com/
Product-Videos

Bulks

Holds face masks in bulk quantities.



FD-005 (PET) (ABS)
One Box Capacity



FM401-0111 (PET) (4") (new)
4" Earloops



FM402-0111 (PET) (4") (new)
4" Face Shields



FP-017 (PET)
Compact



BK004-0111 (PET) (new)
Large Capacity

All consumable items are for demonstration purposes only and are not available for purchase through BOWMAN®

Combo

Multiple styles of face masks in one location.



top seller **FM004-0212** (ABS) (PET)
Surgical with Signs
Three MP-035 Sign Holders included
Also available without sign holders
FM001-0212



FM002-0212 (ABS)
Combo

Exact Fit

Exact fit for most standard size boxes.



top seller **FB-037** (CRS)
Earloops



top seller **FB-090** (CRS)
Face Shields



top seller **FB-091** (CRS)
Ties

Universal

- Switch your supplier and keep your dispenser
- Holds a variety of boxed face masks
- Accommodates most brands

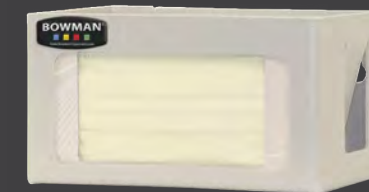

FM100-0212 (ABS)
Earloops





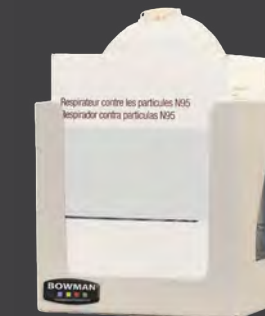



FM200-0212 (ABS)
Face Shields











FM300-0212 (ABS)
Cones

PATENT: www.BowmanDispensers.com/patents

Face Mask Dispensers Cross Reference Guide		Dispenser Dims W (L) x H x D		3M	Cardinal Health	Condor	Gerson	Halyard Health	McKesson
		IN	CM						
EARLOOP	Box  (ABS) FM100-0212	8.25 4.63 5.75	21.0 11.8 14.6	1800, 1816, 1820, 1826, 1832, 1838	AT71021, AT7511, AT7511-WE, AT771141, AT771211, AT771212			28802, 28806, 28808, 37525, 39117, 41805, 48100, 48105, 48201, 48215, 48296, 49214, 49310, 49701, 59927, 59928, 59929, 59931, 62113, 62367, 62369	91-1000, 91-1200, 91-1400, 91-2002
	Bulk  (PET) 4" FM401-0111	8.50 5.60 4.06	21.5 14.2 10.3						
SHIELD	Box  (ABS) FM200-0212	9.75 8.63 4.75	24.8 21.9 12.1	1818, 1870, 1870-N95, 9210/37021	AT51035, AT51334, AT54635, AT71035, AT71039, AT72835, AT73335, AT73835, AT744235, AT744335, AT74535, AT74631, AT74635, AT7505-P, AT752005, AT752007, AT771145, N95A-ML	22EL77		28804, 28809, 28821, 39123, 41803, 47095, 47137, 47147, 47148, 47149, 47298, 47500, 48228, 48237, 48247, 48248, 48257, 48298, 59930, 59937, 62114, 62116, 69801	91-1600, 91-2600
	Bulk  (PET) 4" FM402-0111	12.00 9.00 4.08	30.5 22.9 10.4						
CONE	Box  (ABS) FM300-0212	6.75 7.13 5.75	17.1 18.1 14.6	1860, 8000, 8210, 8240, 8246, 8247, 8511, 8576, 8577, 1800+NL, 1800NL, 1860S	N95A-S	22EL78, 22EL79, 22EL80, 22EL81, 4KMX9		47200, 47407, 47707, 47817, 62127, 62354, 63037, 63149, 63152	
	Bulk  (PET) FP-017	6.70 9.19 6.01	17.0 23.3 15.3						
	Bulk  (PET) BK004-0111	9.00 12.69 5.96	22.9 32.2 15.1						

MediChoice PrimaGuard/PriMed	Medline	Moldex	NovaPlus	Precept	Premier Pro	Sperian
PG41092, PG41200, PG41201, PG41241, PG42001, PG42331, PG42332, PG42421, PG44241	NON27110, NON27120, NON27120-2, NON27122, NON27355, NON27361A, NON27365, NON27373A, NON27374, NON27375, NON27376, NON27377, NON27378, NON27378A, NON27379A, NON27382, NON27382FR, NON27385, NON27386, NON27400, NON27402, NON27408, NON27408EL, NON27410, NON27410EL, NON27412, NON27412EL, NON27600, NON27600AG, NON27710, NON27710EL, NON27712, NON27712EL, NON27810, NON27810EL, NON27812EL		V47572, V47578	15100, 15101, 15130, 15150, 15155, 15160, 15200, 15211, 15212, 15216, 15220, 15230, 15240, 15260, 15300, 15320, 15420, 15500, 65-3320, 65-3322	2460, 2463, 2464, 2465, 2466, 2470, 2472	
PG41573, PG41592, PG42560, PG42562, PG43573, PG45073, PG46003, PG46403	NON27405, NON27411, NON27411AG		V47570	15310, 15330, 15710, 65-3344	2451, 2461, 2462, 2467, 2480, 2481, 2492	7230N95
PG4303	N7120, NON24506A, NON24570A, NON27381	1510, 1511, 1512, 1513, 1517, 1712, 2112, 2250, 2350, 2850, 4200, 4201, 4600, 4601, 4800, 1200N95, 1201N95, 1207N95, 2200N95, 2200N95HV, 2201N95, 2207N95, 2210GN95, 2211GN95, 2212GN95, 2217GN95, 2300N95, 2301N95, 2307N95, 2600N95, 2601N95, 2607N95, 2700N95, 2701N95, 2707N95, 2730N100, 2731N100, 2740R95, 2741R95, 2800N95, 2801N95, 2840R95, 2841R95, 2940R95, 2941R95, 4300P95, 4700N100, D2740R95, M2600N95, M2601N95, M2700N95, M2701N95, M2707N95, M2740R95, M2741R95, M2800N95, M2801N95, M2840R95		65-3333, 65-3395, 65-3395S	2490	14110388

Information in this cross reference is subject to change.

Face Mask Dispensers Cross Reference Guide		Dispenser Dims W (L) x H x D		3M	Cardinal Health	Condor	Gerson	Halyard Health	McKesson
		IN	CM						
EARLOOP	 FB-037	7.56 4.25 4.13	19.2 10.8 10.5		AT7511, AT71021, AT771141, AT771211, AT771212			25867, 25868, 25869, 28797, 28810, 32856, 41802, 47080, 47085, 47090, 47107, 47108, 47117, 47119, 47127, 47295, 47297, 49700, 59936, 59938, 59939, 59940, 62115, 62356, 62357, 62362, 62363, 62364	91-2002
EARLOOP	 FB-064	7.56 4.25 4.13	19.2 10.8 10.5		AT71021, AT7511, AT771141, AT771211, AT771212			25867, 25868, 25869, 28797, 28810, 32856, 41802, 47080, 47085, 47090, 47107, 47108, 47117, 47119, 47127, 47295, 47297, 49700, 59936, 59938, 59939, 59940, 62115, 62356, 62357, 62362, 62363, 62364	91-2002
SHIELD	 FB-090	9.06 7.53 4.06	23.0 19.1 10.3	1818	AT54635, AT71039, AT744335, AT74631, AT74635, AT7509			28804, 28809, 28821, 41803, 47137, 47147, 47148, 47149, 47298, 47500, 48228, 48237, 48247, 48248, 48257, 48298, 59930, 59937, 62114, 62116, 69801	91-1600, 91-2600
TIE	 FB-091	7.90 7.70 5.00	20.1 19.6 12.7	1832	AT51035, AT51334, AT71035, AT72835, AT73335, AT73835, AT744235, AT74535, AT7505-P, AT752005, AT752007, AT75835, AT771145, N95A-ML			28820, 37505, 37510, 39125, 47625, 47650, 48207, 48208, 48210, 48220, 48225, 48227, 48297, 48390, 49210, 49212, 49215, 49216, 49230, 49235, 59926, 62368	
SHIELD	 FM006-0111	11.83 7.50 4.20	30.0 19.0 10.7		AT74635-I, AT771145A			39118, 39124	
EARLOOP	 FP-021	7.95 4.23 5.20	20.2 10.7 13.2		N95A-ML				91-1200
EARLOOP	 FP-038	7.70 4.32 4.27	19.6 11.0 10.8		AT71021, AT7511, AT771141, AT771211, AT771212			25867, 25868, 25869, 28797, 28802 28806, 28808, 28810, 32856, 37525, 41802, 41805, 47080, 47085, 47090, 47107, 47108, 47117, 47119, 47127, 47295, 47297, 48100, 48105, 48201, 48215, 48296, 49214, 49310, 49700, 49701, 59927, 59928, 59929, 59931, 59936, 59938, 59939, 59940, 62113, 62115, 62356, 62357, 62362, 62363, 62364, 62367, 62369	91-2002
SHIELD	 FP-120	9.20 7.50 4.20	23.4 19.1 10.7		AT54635, AT71021, AT71039, AT744335, AT74631, AT74635, AT7511, AT771141, AT771211, AT771212			28804, 28809, 28821, 41803, 47137, 47147, 47148, 47149, 47298, 47500, 48228, 48237, 48247, 48248, 48257, 48298, 59930, 59937, 62114, 62116, 69801	91-1600, 91-2600

Information in this cross reference is subject to change.

MediChoice PrimaGuard/PriMed	Medline	Moldex	NovaPlus	Precept	Premier Pro	Sperian
PG41092, PG41200, PG41241, PG42331	NON27120-2, NON27122, NON27355, NON27375, NON27378		V47566, V47567, V47568, V47569, V47573		2450	
PG41092, PG41200, PG41241, PG42331	NON27120-2				2450	
PG41573, PG41592, PG45073	NON27361A, NON27410EL, NON27710EL, NON27810EL, NON27361A, NON27371A, NON27376, NON27377, NON27385, NON27386, NON27400, NON27408, NON27408EL, NON27710EL			15310, 15330, 15710, 65-3344		
PG43573	NON27412, NON27371A, NON27712				2462	
PG41241, PG42332				15100, 15101, 15130, 15150, 15155, 15160, 15200, 15211, 15212, 15216, 15220, 15230, 15240, 15260, 15300, 15320, 15420, 15500, 65-3320, 65-3322	2450	
PG41092, PG41200, PG41201, PG41241, PG42331	NON27110, NON27120-2, NON27365, NON27374, NON27410, NON27410EL, NON27600, NON27600AG, NON27710, NON27710EL, NON27810, NON27810EL				2410, 2420, 2430, 2452, 2453, 2454	
PG41573, PG41592, PG45073	NON24505			15310, 15330, 15710, 65-3344		14110452

limitless

ORGANIZING & STORAGE OPTIONS

From caps and booties to coffee pods and candy, Bulk Dispensing Solutions from BOWMAN offer convenient storage and accessibility—for any market.



Bottom & Top Dispensing - Tall Bulk Bins



Stainless Steel
FLOW-THROUGH DISPENSING



BK001-0300 (STS)
Tall Single



BK312-0300 (STS) 
Tall Double



BK313-0300 (STS) 
Tall Triple



BK314-0300 (STS) 
Tall Quad

All consumable items are for demonstration purposes only and are not available for purchase through BOWMAN®

Bottom & Top Dispensing - Short Bulk Bins



Clear PETG Plastic
FLOW-THROUGH DISPENSING

Our Flow-Through system feature offers you the convenience of loading consumables from the top and dispensing from the top or bottom. Available in PETG Plastic and Stainless Steel. See pages 60-61 for other load/dispensing options.



BP-021 (PET)
Short Single
Also available -
BK002-0300 (STS)



BP-022 (PET)
Short Double



BP-023 (PET)
Short Triple

unique dispensing features

FIND THE BEST FIT FOR YOUR NEEDS



FLOW-THROUGH FEATURES:

- Top loading
- Dispense from bottom & top
- Available in PETG Plastic and Stainless Steel



TOP-EXCLUSIVE FEATURES:

- Load & dispense one way
- Extra protection from dust & debris
- Best seller for industrial & food service manufacturers



All bulk dispensing options are USP 800 solutions



Gloves

SCRUB BRUSHES STICKY NOTES

HARDWARE TOWELS

TEA BAG & HOT COCOA PACKETS

Boot Covers Small Shop Tools

Beard Covers BOUFFANT CAPS

EARPLUGS Hair Nets

SHOE COVERS

SMALL MEASURING TAPES

Surgeons Caps



Bottom & Top Dispensing - Tall Bulk Bins



Clear PETG Plastic
FLOW-THROUGH DISPENSING



BP-011 (PET)
Tall Single



BP-090 (PET)
Tall Triple



BP-012 (PET)
Tall Double



BK314-0111 (PET) 
Tall Quad



learn more:
[BowmanDispensers.com/
Product-Videos](http://BowmanDispensers.com/Product-Videos)

Top Dispensing - Tall Bulk Bins



Clear PETG Plastic
TOP-EXCLUSIVE DISPENSING



BK211-0111 (PET)
Tall Single



BK212-0111 (PET)
Tall Double



BK213-0111 (PET)
Tall Triple



BK214-0111 (PET) 
Tall Quad



Top Dispensing - Mini Bulk Bins

Clear PETG Plastic
TOP-EXCLUSIVE DISPENSING



BK101-0111 (PET) 
Mini Single



BK102-0111 (PET) 
Mini Double



BK103-0111 (PET) 
Mini Triple

All consumable items are for demonstration purposes only and are not available for purchase through BOWMAN®

find your niche

CONVENIENT ORGANIZATION
FOR SPECIALIZED ITEMS

efficient STERILE PROCEDURE AREAS



Build A Room
by BOWMAN

Build A Room:
Plan and arrange
dispensers using a
photograph of your
space: see pages 74-75

PS026-0212 (ABS) (PET) (USP <800>)
Surgical Apparel Organizer

Exact Fit Bouffant Cap & Shoe Cover Dispensers cross reference: online



BB-034 (CRS)
Bouffant Caps or
Shoe Covers



BP-007 (PET)
Bouffant Caps or
Shoe Covers



SP-003 (PET)
Shoe Covers

Surgical Protection Systems

PS023-0212 (ABS) (USP <800>)
Also available - PS023-0512 (ALM)



PS017-0212 (ABS) (PET) (USP <800>)

Shown below:
Removable shelf creates
2 storage areas
when installed



All consumable items are for demonstration purposes only and are not available for purchase through BOWMAN®

universal satisfaction

THE PERFECT FIT FOR EVERY INDUSTRY

- Accommodating spring loaded design
- Secure fit for PPE such as bouffant caps, shoe covers, gowns, wipes & masks
- Great choice for industrial wipes & masks
- 3 styles shown below hold over 95 different boxes from major manufacturers

 **cross reference:** pg 47 & online



Universal Protection Dispensers









Spring loaded design ensures a secure fit for shoe covers, wipes, caps, masks & more.



PD100-0212  
Standard

PD200-0212  
Large

PD300-0212  
Wide - Mounts vertically or horizontally

Universal Protection Dispensers Cross Reference Guide		  	  	  
Product Description		Universal - Standard	Universal - Large	Universal - Wide
Part Number		PD100-0212	PD200-0212	PD300-0212
W (L) x H x D	IN	12.25 x 10.13 x 7.63	12.50 x 10.13 x 9.88	13.70 x 5.73 x 6.95
	CM	31.1 x 25.7 x 19.4	31.8 x 25.7 x 25.1	34.8 x 14.6 x 17.7
Boot/Shoe Covers		Cardinal Health: 2850, 2852, 2854, 4850, 4854, 4855, 5850, 5852, 5854, 5859 Halyard Health: 69252, 69253, 69254, 69353, 69551, 69571, 69572, 69671, 69672 MediChoice: 77724, 77725, 77726, 77727, 77728, 77729 Medline: CRI2002, CRI2003, NON28758, NON28759, NON28852, NON29858, NON29859 NovaPlus: V4854 Premier Pro: 2260, 2261, 2262, 2263, 2264, 2280, 2281, 2282, 2290, 2291	Cardinal Health: 8357, 8451, 8452, 8453, 8454, 8457, 8458, 8358A Medline: NON27143, NON27143XL, NON27144, NON27144XL, NON27145, NON27150, NON27150XL	Halyard Health: 69252, 69254, 69551
Caps & Hoods		Cardinal Health: 3474, B24HD Halyard Health: 69083, 69086, 69088, 69089, 69110, 69196, 69221, 69240, 69520 MediChoice: 77706, 77707 Medline: NON28228, NON28229, NON28230R, NONSH100C		Cardinal Health: 3290 Halyard Health: 69110, 69196, 69240, 69520 Medline: NON28625, NON28626 NovaPlus: V4359
Face Masks/Shields/Respirators		3M: 9105, 1818FSG, 1838FSG Cardinal Health: F1SHIELD50, H1SHIELD50 Medline: NONFS300 Moldex: 2310, 2315N99, 2400N95, 2500N95 Premier Pro: 2496	Moldex: EZ22, EZ22S	3M: 1818FS, 1820FS, 1835FS, 1840FS Medline: NONFS300 Moldex: 2360AP100 Precept: 65-3348
Gloves				Cardinal Health: N8830, N8831, N8832, N8833
Towels & Wipes			Halyard Health: 41041 Kimberly Clark: 12891, 34015, 41041, 41044, 41300	

Information in this cross reference is subject to change.

Gown Dispensers



GN001-0212 (ABS) (USP -800-)
Gown - Bulk

- Holds a variety of gowns in bulk
- Keyholes for wall mounting or door hanger cutout for use with wall or door hanger



GN100-0212 (ABS)
Gown - Universal Thumb Loop

Change your supplier,
keep your dispenser.

cross reference:
online

Surgical Face Mask & Scrub Sink Area Dispensers



FP-017 (PET) (USP -800-)
Eyewear
Fits Pre-Assembled Eye Shields:
Cardinal Health #CAHEYEWEAR
MediChoice #PEW050
Medline #NONASMBLD



FM001-0212 (ABS)
Surgical Face Mask
Also available with sign
holders FM004-0212



FM013-0212 (ABS) (new)
Face Mask - Triple
Also available as a
quintuple FM014-0212



CL007-0212 (ABS)
Scrub Brush
Smaller alternative
CL006-0212

cross reference:
online

Multipurpose Bedpan & Urinal Dispensers

- Holds most standard size bedpans, bariatric bedpans, fracture pans, specimen collection containers, and up to 2 urinal bottles
- Keyholes for wall mounting



NC012-0412 (CRS) (new)
Shown with oversized bedpan



NC001-0512 (ALM)
Shown with specimen collector pan



Personal Wipe Dispensers

Keep personal wipes easily accessible
and off of the floor or counter.

cross reference: online



CL021-0111 (PET)
Tall
Also available short
CL011-0111



CL022-0111 (PET)
Tall-Thick
Also available short
CL012-0111



safety made simple

BAG, CART COVER, BVM & CPR DISPENSING SOLUTIONS

Large Capacity Bag & Cart Cover Dispenser

- Convenient storage for cart covers or large bags
- Holds one roll up to 12.00" long and 6.00" diameter
- Two-way keyholes for vertical or horizontal wall mounting; if bag roll weighs more than 4.5 lbs., dispenser must be mounted vertically



BG009-0512 (ABS)



Above: Cart covers in use

Bag Dispensers

Single and double dispensers hold a variety of bags up to 9.50" long and 3.40" diameter.



Single
BG001-0212 (ABS)
 Also available -
 BG001-0512 (ALM)
 BG001-0111 (PET)



Double
BG002-0212 (ABS)
 Also available -
 BG002-0512 (ALM)
 BG002-0111 (PET)

cross reference: online

Bag & Glove Protection System



PS004-0212 (ABS)
 Holds one roll of bags up to 9.50" long and 3.40" diameter
 Also available -
 PS004-0111 (PET)

Biohazard Bag Holders



- Options to hold a one, three or five gallon biohazard bag
- Keyholes for wall mounting
- Easy-open hinged lid



MW-001* (ABS) (WIR)
 1 Gallon

MW-003* (ABS) (WIR)
 3 Gallon

MW-005* (ABS) (WIR)
 5 Gallon

*IMPORTED

Respiratory Supplies Dispenser

Holds most major manufacturers' disposable oxygen bag valve masks.



BK501-1211 (PLC)

CPR Holder

Holds most major manufacturers' CPR clam kits.



NC010-0111 (PET)

cross reference: online

cross market

SPECIALTY DISPENSERS

Wall Sign Holder



MP-070 (PET)
Vertical Sign Holder



MP-075 (PET)
Horizontal Sign Holder

Industrial



FP-017 (PET) USP <800>
Compact



BK004-0111 (PET) USP <800> new
Large Capacity



CP-075 (ABS) (PET)
Eyewear Cabinet - Locking
Holds 10 pairs of eyewear
Also available - CP-072
(Holds 5) (ABS) (PET)

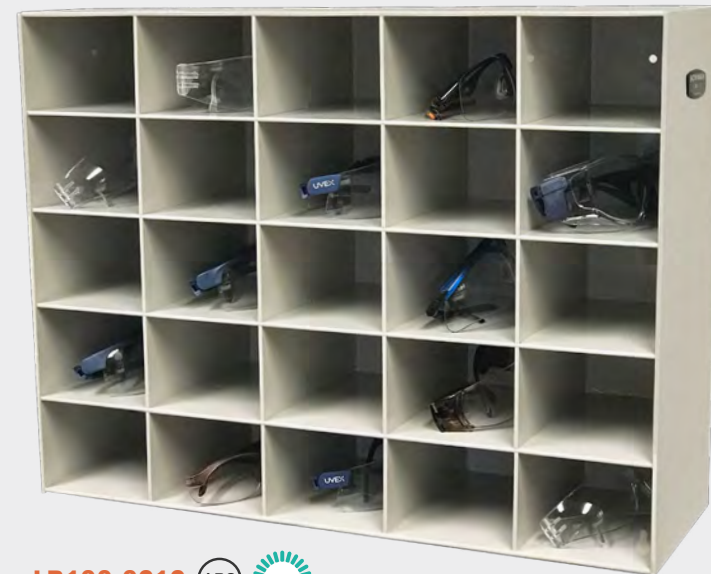

LB100-0212 (ABS) new
Safety Eyewear
Dispenser - Divided

All consumable items are for demonstration purposes only and are not available for purchase through BOWMAN®



Food Service



FS001-0300 (STS)
Wax Paper Dispenser
Also available - FS001-0111 (PET)
cross reference: online



HP-010 (PET)
Hairnet Dispenser



GL102-0300 (STS)
Glove Box Dispenser - Single
Also available - GL102-0111 (PET)
cross reference: online



TB-003 (CRS)
Towel Dispenser

Dental



MD-100 (ABS) (PET)
Dental Organizer





Signature Series:
naturally
SUITED TO YOUR SPACE

Signature Series
FEATURES:

- Natural woodgrain appearance compliments any interior
- All styles shown available in Cherry or Maple Fauxwood
- Visually appealing, upscale option
- Increases customer satisfaction
- Strong and durable
- Easy to clean; stands up to hospital grade cleaners
- Most BOWMAN dispensers can be custom ordered with Signature Series materials; minimum order quantities may apply

Cover Your Cough Kits

Everything you need in one convenient kit; see pages 26-33 for more details.

BD212-0023 (AFP)

Countertop or Wall Mount Station & Sign

Also available in Cherry - BD212-0033



BD111-0033 (AFP)

Freestanding Station, Stand & Sign

Also available in Maple - BD111-0023



Glove Box Dispensers

Three-way keyholes for vertical or horizontal mounting.



GL010-0223 (AFP)

Also available in Cherry - GL010-0233



GL020-0233 (AFP)

Also available in Maple - GL020-0223



GL030-0223 (AFP)

Also available in Cherry - GL030-0233



GL040-0233 (AFP)

Also available in Maple - GL040-0223

Protection Systems

Mount to wall, door or glass: see pages 10-11 & 16-17 for more details.



BD601-0033 (AFP)



BD601-0023 (AFP)



Build A Room by BOWMAN

BuildARoomByBowman.com

bring your vision to life

Build A Room shows you the end result in just a few clicks with a camera and a mouse. Create, save and output an image of your ideal room, like the one shown at right.



plan, design, execute

From taking a photo of the area you want to outfit with dispensers, to arranging them according to your needs, you are in complete control of the whole process.

Build A Room is exclusive to BOWMAN Dispensers:

- Visually plan out your workflow, organization and storage needs
- See firsthand how dispensers will fit in your space
- Arrange, align, and rearrange until you have the perfect placement
- Try out multiple combinations with no commitment to purchase
- Print and download your final layout
- Saved PDF includes a list of your chosen dispensers for reference

Create your ideal working environment in just a few easy steps at BuildARoomByBowman.com:



Choose the consumable(s) and room(s) that need organization.



Tape an 8 1/2" x 11" piece of paper to the wall and take a photo straight on of the room.



Select your dispenser category in Build A Room and upload your photo.

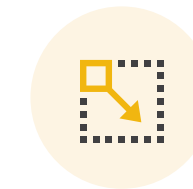

Arrange the yellow square to fill your paper in the photo.



Drag and drop dispensers into your space.



Save your design then print or send your layout to your planning team.

Success is in the details

Integrate PPE Dispensing Solutions into the project planning phase to save space, improve aesthetics and reduce code violations.



value adds

FOR EVERY PROJECT

- Semi-recessed, interior cabinet, custom & stock PPE dispensing solutions
- Material options for any budget
- Finish options for any interior
- All products offer best functionality and quality aesthetics
- Strong materials withstand heavy use & hospital grade cleaning products

Get started today: 800-962-4660



free planning tools:
Find our Audit Tool and Hospital Dispenser Planning Checklist and more at BowmanDispensers.com



build a room:
Plan and arrange dispensers using a photograph of your space: see pages 74-75



learn more:
BowmanDispensers.com/Product-Videos

Semi-Recessed Solutions BEAUTIFULLY COMPLIANT

- Keeps high traffic areas clear & avoids wall protrusion rules
- Variety of layout options for glove dispensing, flu prep, & protection systems
- Available through the BOWMAN Custom Design Program



RE101-0012 (CRS)

Protection System - Standard
24.36"W x 27.65"H x 4.77"D

More Semi-Recessed
Dispensing options on
pages 78-83.

Interior Cabinet Dispensing BUILT-IN ESSENTIALS

- Frees up space on countertops and walls with a polished look
- Available for select stock dispensers & any custom designed products



GB-144 (CRS)

Glove Box Dispenser - Single
Unmounted View



GL300-1214 (PLC)

Glove Box Dispenser - Triple with Dividers
Left: Side view
Right: Inside dental office cabinet

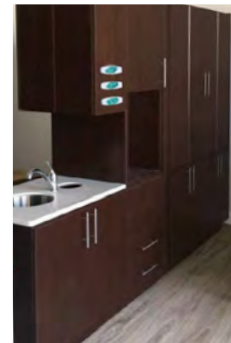

Ready-to-Install Stock Designs EASY OPTIONS

- A variety of colors and materials
- Expedited shipping available for quick turn-around projects
- Some of our best sellers are shown below; browse through the catalog to see a large variety of options



NC001-0512 (ALM)

Bedpan/Urinal
Dispenser



GL030-0223 (AFP)

Glove Box Dispenser
Triple with Dividers

Custom Designs UNIQUE LOCATION SOLUTIONS

- If you can dream it, we can do it
- Minimum order quantities may apply

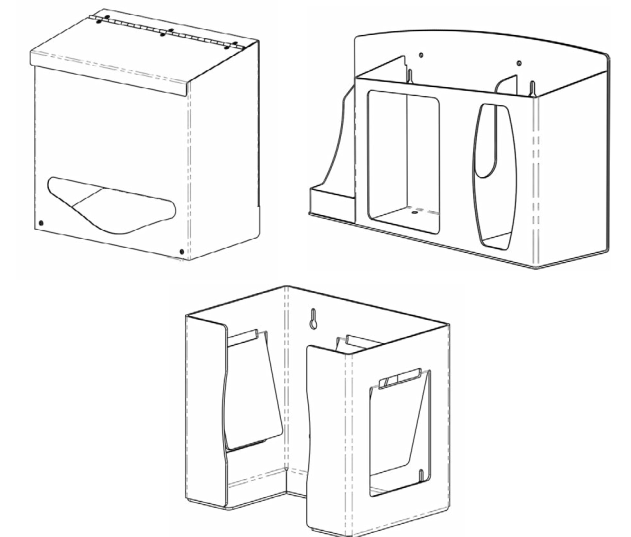

ADA compliant

EXCLUSIVELY
BOWMAN



PATENT: www.BowmanDispensers.com/patents

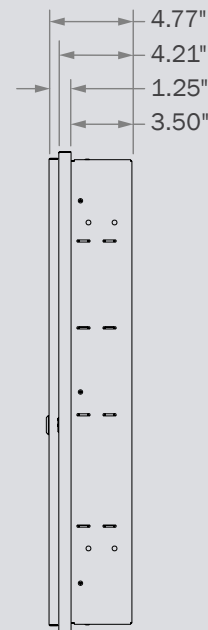

Center Side View Installation Specs for All Semi-Recessed Units

- 4.77" - Overall depth to face of door
- 4.21" - Overall depth to front of frame
- 1.25" - Depth of installed wall protrusion
- 3.50" - Semi-Recessed depth

Measurements shown are overall external dimensions. For complete details on measurements and specifications, download product datasheets at BowmanDispensers.com

Semi-Recessed Protection Systems are a smart choice for high traffic areas, such as hallways or near elevators. Our in-wall solutions avoid wall protrusion rule concerns while keeping necessities organized and at hand.

FEATURING:

- ADA compliance benefit; once installed protrusion is approximately 1 1/4"
- Simplifies supply location standardization
- Visible access to supplies improves PPE donning compliance and restocking
- Universally sized to hold most major brands of PPE consumables
- Improves HCAHPS scores with a sleek, organized, and aesthetically pleasing design
- One in-wall well, adjustable shelves, and interchangeable doors
- Additional layouts and custom designs available
- Made in the USA out of Quartz Beige Powder-Coated Steel

semi-recessed video:
[BowmanDispensers.com/
Product-Videos](http://BowmanDispensers.com/Product-Videos)



BACKED BY OUR
15 YEAR
WARRANTY



Protection Systems



RE101-0012 CRS

Protection System - Standard
24.36"W x 27.65"H x 4.77"D
Pg 78: Partial Open View

All consumable items are for demonstration purposes only and are not available for purchase through BOWMAN®.

ADDITIONAL recessed SOLUTIONS

PATENT: www.BowmanDispensers.com/patents



Space Conscious

Renovating an existing area with space constraints? BOWMAN has a narrow solution.



RE501-0012 CRS
Protection System
Space Saver
18.77"W
34.66"H
4.77"D



RE502-0012 CRS
Protection System
Space Saver
18.77"W
34.66"H
4.77"D



Large Capacity Gown

Save on restocking time with the double gown option.



RE201-0012 CRS
Protection System - Double Gown
27.38"W x 33.33"H x 4.77"D
Shown with optional
MP-047 sign holder

Covered Supplies

Keep supplies out of sight.



RE103-0012 CRS
Protection System - Solid Door
24.36"W x 27.65"H x 4.77"D

Eco-Friendly

Reusable gown storage is an environmentally friendly and cost effective solution.



RE201-0012 CRS
Protection System
Double Gown
27.38"W
33.33"H
4.77"D



RE202-0012 CRS
Protection System
Reusable Gown
27.38"W
33.33"H
4.77"D
Shown with optional
MP-047 sign holder



Don't see what you need? Custom designs are available, contact: sales@BowmanDispensers.com



PATENT: www.BowmanDispensers.com/patents

protect

YOUR PATIENTS,
YOURSELF
& YOUR FAMILY



PERFECT FIT universal appeal

FEATURING:

- One in-wall well with adjustable shelving
- Keyless, quarter-turn lock to secure door
- Optional glove size indicator
- Innovative and aesthetically pleasing design

Glove Box Dispensers



RE301-0012 (CRS)
Triple
12.34"W x 18.83"H x 4.77"D

RE404-0012 (CRS)
Quad
12.34"W x 24.48"H x 4.77"D

RE304-0012 (CRS) **new**
Hand Sanitizer Station
12.35"W x 18.85"H x 4.22"D

- Universal Wall well for housing hand sanitizer dispensers
- Embossed drip tray designed to contain over dispensing
- Accommodates most front loading hand sanitizer manufacturers dispensers (required dispensing clearance) less than: 11.30"W x 17.94"H x 5.00"D



SN304-0713 (STP) **new**
Sign - Hand Sanitizer Station
6.30"W x 6.00"H x 3.71"D

- Optional 3D sign
- "V" shape projects 45° from wall allowing for easy visualization from front and sides.

 **semi-recessed video:**
[BowmanDispensers.com/
Product-Videos](http://BowmanDispensers.com/Product-Videos)

Hygiene Dispensers



RE401-0012 (CRS)
Face Mask & Glove
Box Dispenser
12.34"W x 24.48"H x 4.77"D



RE302-0012 (CRS)
Face Mask & Tissue
Dispenser
12.34"W x 18.83"H x 4.77"D

Part Number	Product Name	Page	Unit	W (L)	H	D	Product Weight	
BB-034	Bouffant Cap or Shoe Cover Dispenser - White Powder-Coated Steel	63	IN	10.06	10.00	5.31	LB	2.2
			CM	25.6	25.4	13.5	KG	1.0
BD101-0012	Cover Your Cough Compliance Kit (Bottle) with Vertical Sign Holder - Includes: Quartz Beige Powder-Coated Steel Station, Quartz Beige Powder-Coated Steel Floor Stand, Clear PETG Plastic Sign Holder	Referenced: 33	IN	18.00	59.10	18.00	LB	20.7
			CM	45.7	150.1	45.7	KG	9.4
BD102-0012	Cover Your Cough Compliance Kit (Bottle) with Horizontal Sign Holder - Includes: Quartz Beige Powder-Coated Steel Station, Quartz Beige Powder-Coated Steel Floor Stand, Clear PETG Plastic Sign Holder	Not Pictured	IN	18.00	56.60	18.00	LB	20.7
			CM	45.7	143.8	45.7	KG	9.4
BD105-0012	Cover Your Cough Compliance Kit (Back Plate) - Locking with Vertical Sign Holder - Includes: Quartz Beige Powder-Coated Steel Station, Quartz Beige Powder-Coated Steel Floor Stand, Clear PETG Plastic Sign Holder	Not Pictured	IN	22.25	60.48	18.00	LB	22.0
			CM	56.5	153.6	45.7	KG	10.0
BD106-0012	Cover Your Cough Compliance Kit (Back Plate) - Locking with Horizontal Sign Holder - Includes: Quartz Beige Powder-Coated Steel Station, Quartz Beige Powder-Coated Steel Floor Stand, Clear PETG Plastic Sign Holder	Referenced: 32	IN	22.25	57.98	18.00	LB	22.0
			CM	56.5	147.3	45.7	KG	10.0
BD111-0012	Cover Your Cough Compliance Kit (Bottle) with Vertical Sign Holder - Includes: Quartz Beige ABS Plastic Station, Quartz Beige Powder-Coated Steel Floor Stand, Clear PETG Plastic Sign Holder	33	IN	18.00	58.36	18.00	LB	19.2
			CM	45.7	148.2	45.7	KG	8.7
BD111-0023	Cover Your Cough Compliance Kit (Bottle) with Vertical Sign Holder - Includes: Fauxwood Maple ABS Plastic Station, White Powder-Coated Steel Floor Stand, Clear PETG Plastic Sign Holder	Referenced: 33	IN	18.00	58.36	18.00	LB	19.3
			CM	45.7	148.2	45.7	KG	8.8
BD111-0033	Cover Your Cough Compliance Kit (Bottle) with Vertical Sign Holder - Includes: Fauxwood Cherry ABS Plastic Station, Black Powder-Coated Steel Floor Stand, Clear PETG Plastic Sign Holder	72	IN	18.00	58.36	18.00	LB	18.8
			CM	45.7	148.2	45.7	KG	8.5
BD112-0012	Cover Your Cough Compliance Kit (Bottle) with Horizontal Sign Holder - Includes: Quartz Beige ABS Plastic Station, Quartz Beige Steel Floor Stand, Clear PETG Plastic Sign Holder	Not Pictured	IN	18.00	55.86	18.00	LB	19.3
			CM	45.7	141.9	45.7	KG	8.8
BD112-0023	Cover Your Cough Compliance Kit (Bottle) with Horizontal Sign Holder - Includes: Fauxwood Maple ABS Plastic Station, White Powder-Coated Steel Floor Stand, Clear PETG Plastic Sign Holder	Not Pictured	IN	18.00	55.86	18.00	LB	18.9
			CM	45.7	141.9	45.7	KG	8.6
BD112-0033	Cover Your Cough Compliance Kit (Bottle) with Horizontal Sign Holder - Includes: Fauxwood Cherry ABS Plastic Station, Black Powder-Coated Steel Floor Stand, Clear PETG Plastic Sign Holder	Not Pictured	IN	18.00	55.86	18.00	LB	18.9
			CM	45.7	141.9	45.7	KG	8.6
BD114-0012	Cover Your Cough Compliance Kit (Back Plate) with Horizontal Sign Holder - Includes: Quartz Beige ABS Plastic Station, Quartz Beige Powder-Coated Steel Floor Stand, Clear PETG Plastic Sign Holder	Referenced: 32	IN	22.25	58.06	18.00	LB	18.6
			CM	56.5	147.5	45.7	KG	8.4
BD115-0012	Cover Your Cough Compliance Kit (Back Plate) - Locking with Vertical Sign Holder - Includes: Quartz Beige ABS Plastic Station, Quartz Beige Powder-Coated Steel Floor Stand, Clear PETG Plastic Sign Holder	Not Pictured	IN	22.25	60.79	18.00	LB	20.7
			CM	56.5	154.4	45.7	KG	9.4
BD115-0023	Cover Your Cough Compliance Kit (Back Plate) - Locking with Vertical Sign Holder - Includes: Fauxwood Maple ABS Plastic Station, White Powder-Coated Steel Floor Stand, Clear PETG Plastic Sign Holder	Not Pictured	IN	22.25	60.79	18.00	LB	20.7
			CM	56.5	154.4	45.7	KG	9.4
BD115-0033	Cover Your Cough Compliance Kit (Back Plate) - Locking with Vertical Sign Holder - Includes: Fauxwood Cherry ABS Plastic Station, Black Powder-Coated Steel Floor Stand, Clear PETG Plastic Sign Holder	Not Pictured	IN	22.25	60.79	18.00	LB	20.7
			CM	56.5	154.4	45.7	KG	9.4
BD116-0012	Cover Your Cough Compliance Kit (Back Plate) - Locking with Vertical Sign Holder - Includes: Quartz Beige ABS Plastic Station, Quartz Beige Powder-Coated Steel Floor Stand, Clear PETG Plastic Sign Holder	32	IN	22.25	58.29	18.00	LB	20.8
			CM	56.5	148.1	45.7	KG	9.4
BD116-0023	Cover Your Cough Compliance Kit (Back Plate) - Locking with Vertical Sign Holder - Includes: Fauxwood Maple ABS Plastic Station, White Powder-Coated Steel Floor Stand, Clear PETG Plastic Sign Holder	Referenced: 32	IN	22.25	58.29	18.00	LB	20.8
			CM	56.5	148.1	45.7	KG	9.4
BD116-0033	Cover Your Cough Compliance Kit (Back Plate) - Locking with Vertical Sign Holder - Includes: Fauxwood Cherry ABS Plastic Station, Black Powder-Coated Steel Floor Stand, Clear PETG Plastic Sign Holder	Referenced: 32	IN	22.25	58.29	18.00	LB	20.8
			CM	56.5	148.1	45.7	KG	9.4
BD162-0012	Cover Your Cough Compliance Kit (Bottle) - Locking with Vertical Sign Holder - Includes: Quartz Beige ABS Plastic Station, Quartz Beige Powder-Coated Steel Floor Stand, Clear PETG Plastic Sign Holder	Referenced: 33	IN	18.50	57.44	18.00	LB	20.3
			CM	47.0	145.9	45.7	KG	9.2
BD201-0012	Cover Your Cough Compliance Kit (Bottle) with Vertical Sign Holder - Includes: Quartz Beige Powder-Coated Steel Station, Clear PETG Plastic Sign Holder	Referenced: 31	IN	17.90	23.04	5.14	LB	4.5
			CM	45.5	58.5	13.1	KG	2.0
BD202-0012	Cover Your Cough Compliance Kit (Bottle) with Horizontal Sign Holder - Includes: Quartz Beige Powder-Coated Steel Station, Clear PETG Plastic Sign Holder	Not Pictured	IN	17.90	20.54	5.14	LB	4.7
			CM	45.5	52.2	13.1	KG	2.1
BD205-0012	Cover Your Cough Compliance Kit (Back Plate) - Locking with Vertical Sign Holder - Includes: Quartz Beige Powder-Coated Steel Station, Clear PETG Plastic Sign Holder	Not Pictured	IN	22.25	24.42	5.00	LB	5.3
			CM	56.5	62.0	12.7	KG	2.4
BD206-0012	Cover Your Cough Compliance Kit (Back Plate) - Locking with Horizontal Sign Holder - Includes: Quartz Beige Powder-Coated Steel Station, Clear PETG Plastic Sign Holder	Referenced: 30	IN	22.25	21.92	5.00	LB	5.4
			CM	56.5	55.7	12.7	KG	2.4
BD211-0012	Cover Your Cough Compliance Kit (Bottle) with Vertical Sign Holder - Includes: Quartz Beige ABS Plastic Station, Clear PETG Plastic Sign Holder	31	IN	17.90	22.30	4.45	LB	3.2
			CM	45.5	56.6	11.3	KG	1.5

Part Number	Product Name	Page	Unit	W (L)	H	D	Product Weight	
BD211-0023	Cover Your Cough Compliance Kit (Bottle) with Vertical Sign Holder - Includes: Fauxwood Maple ABS Plastic Station, Clear PETG Plastic Sign Holder	Referenced: 31	IN	17.90	22.30	4.45	LB	3.3
			CM	45.5	56.6	11.3	KG	1.5
BD211-0033	Cover Your Cough Compliance Kit (Bottle) with Vertical Sign Holder - Includes: Fauxwood Cherry ABS Plastic Station, Clear PETG Plastic Sign Holder	Referenced: 31	IN	17.90	22.30	4.45	LB	3.3
			CM	45.5	56.6	11.3	KG	1.5
BD212-0012	Cover Your Cough Compliance Kit (Bottle) with Horizontal Sign Holder - Includes: Quartz Beige ABS Plastic Station, Clear PETG Plastic Sign Holder	Not Pictured	IN	17.90	19.80	4.45	LB	3.3
			CM	45.5	50.3	11.3	KG	1.5
BD212-0023	Cover Your Cough Compliance Kit (Bottle) with Horizontal Sign Holder - Includes: Fauxwood Maple ABS Plastic Station, Clear PETG Plastic Sign Holder	72	IN	17.90	19.80	4.45	LB	3.3
			CM	45.5	50.3	11.3	KG	1.5
BD212-0033	Cover Your Cough Compliance Kit (Bottle) with Horizontal Sign Holder - Includes: Fauxwood Cherry ABS Plastic Station, Clear PETG Plastic Sign Holder	Referenced: 72	IN	17.90	19.80	4.45	LB	3.3
			CM	45.5	50.3	11.3	KG	1.5
BD214-0012	Cover Your Cough Compliance Kit (Back Plate) with Horizontal Sign Holder - Includes: Quartz Beige ABS Plastic Station, Clear PETG Plastic Sign Holder	Referenced: 30	IN	22.25	22.40	5.00	LB	5.0
			CM	56.5	56.9	12.7	KG	2.3
BD215-0012	Cover Your Cough Compliance Kit (Back Plate) - Locking with Vertical Sign Holder - Includes: Quartz Beige ABS Plastic Station, Clear PETG Plastic Sign Holder	Not Pictured	IN	22.25	24.90	5.00	LB	5.1
			CM	56.5	63.2	12.7	KG	2.3
BD216-0012	Cover Your Cough Compliance Kit (Back Plate) - Locking with Horizontal Sign Holder - Includes: Quartz Beige ABS Plastic Station, Clear PETG Plastic Sign Holder	30	IN	22.25	22.40	5.00	LB	5.0
			CM	56.5	56.9	12.7	KG	2.3
BD262-0012	Cover Your Cough Compliance Kit (Bottle) - Locking with Vertical Sign Holder - Includes: Quartz Beige ABS Plastic Station with Clear PETG Plastic Lid, Clear PETG Plastic Sign Holder	31	IN	17.52	21.36	5.62	LB	4.3
			CM	44.5	54.2	14.3	KG	2.0
BD322-0012	Cover Your Cough Compliance Kit - Locking with Vertical Sign Holder - Includes: Quartz Beige ABS Plastic Station, Clear PETG Plastic Sign Holder	30	IN	13.80	24.08	5.47	LB	3.1
			CM	35.1	61.2	13.9	KG	1.4
BD412-0012	Protection System Isolation Kit - Includes: PS412-0212, MP-047	Referenced: 13	IN	23.38	26.73	4.33	LB	8.0
			CM	59.4	67.9	11.0	KG	3.6
BD415-0012	Protection System Isolation Kit - Includes: PS415-0212, MP-047	Referenced: 13	IN	25.11	30.05	4.35	LB	8.1
			CM	63.8	78.4	11.0	KG	3.7
BD464-0012	Protection System Isolation Kit - Includes: LD-064, MP-047	Referenced: 12	IN	16.76	25.73	4.35	LB	3.7
			CM	42.5	65.1	10.2	KG	1.7
BD601-0012	Protection System Isolation Kit - Includes: PS016-0212, MP-047	Referenced: 13	IN	23.38	26.63	5.38	LB	8.3
			CM	59.4	67.6	13.7	KG	3.8
BD601-0023	Protection System Isolation Kit - Includes: PS016-0223, MP-047	73	IN	23.38	26.63	5.38	LB	8.3
			CM	59.4	67.6	13.7	KG	3.8
BD601-0033	Protection System Isolation Kit - Includes: PS016-0233, MP-047	73	IN	23.38	26.63	5.38	LB	8.3
			CM	59.4	67.6	13.7	KG	3.8
BD602-0012	Protection System Isolation Kit - Includes: PS016-0212, MB-600, MP-047	Referenced: 13	IN	23.38	36.51	5.40	LB	9.3
			CM	59.4	92.7	13.7	KG	4.2
BD607-0012	Protection System Isolation Kit - Includes: LD-007, MB-600	Referenced: 12	IN	16.63	36.16	7.05	LB	5.0
			CM	42.2	91.8	17.9	KG	2.3
BD615-0012	Protection System Isolation Kit - Includes: PS015-0212, MP-047, MB-600	Referenced: 13	IN	25.15	40.41	7.63	LB	11.4
			CM	63.9	102.6	19.4	KG	5.2
BD625-0012	Protection System Isolation Kit - Includes: PS015-0212, MP-047	Referenced: 13	IN	25.15	30.98	5.08	LB	10.3
			CM	63.9	78.7	12.9	KG	4.7
BD637-0012	Protection System Isolation Kit - Includes: LD-037, MP-047, MB-600	Referenced: 12	IN	23.50	30.43	7.63	LB	7.5
			CM	59.7	77.3	19.4	KG	3.4
BD638-0012	Protection System Isolation Kit - Includes: LD-037, MP-047	Referenced: 12	IN	23.50	20.80	5.08	LB	6.5
			CM	59.7	52.8	12.9	KG	2.9
BD670-0012	Protection System Isolation Kit - Includes: LD-070, MB-600	Referenced: 12	IN	20.05	36.16	7.30	LB	5.4
			CM	50.9	91.8	18.5	KG	2.4
BG001-0111	Bag Dispenser - Single - Clear PETG Plastic	Referenced: 68	IN	10.10	3.60	3.95	LB	0.7
			CM	25.7	9.1	10.0	KG	0.3

Part Number	Product Name	Page	Unit	W (L)	H	D	Product Weight	
BG001-0212	Bag Dispenser - Single - Quartz Beige ABS Plastic	68	IN	10.10	3.60	3.96	LB	0.6
			CM	25.7	9.1	10.0	KG	0.2
BG001-0512	Bag Dispenser - Single - Quartz Beige Powder-Coated Aluminum	Referenced: 68	IN	10.05	3.50	3.90	LB	0.9
			CM	25.5	8.9	9.9	KG	0.4
BG002-0111	Bag Dispenser - Double - Clear PETG Plastic	Referenced: 68	IN	10.13	7.13	3.96	LB	1.0
			CM	25.7	18.0	10.0	KG	0.4
BG002-0212	Bag Dispenser - Double - Quartz Beige ABS Plastic	68	IN	10.13	7.13	3.96	LB	1.0
			CM	25.7	18.0	10.0	KG	0.4
BG002-0512	Bag Dispenser - Double - Quartz Beige Powder-Coated Aluminum	Referenced: 68	IN	10.05	7.00	3.90	LB	1.3
			CM	25.5	17.8	9.9	KG	0.6
BG008-0111	Bulk Dispenser - Flat Pack Bio Bag - Clear PETG Plastic	Not Pictured	IN	6.20	11.10	3.20	LB	0.8
			CM	15.7	28.2	8.1	KG	0.4
BG009-0512	Bag Dispenser - Single - Large Capacity - Quartz Beige Powder-Coated Aluminum	68	IN	12.00	6.35	6.40	LB	1.6
			CM	30.5	16.1	16.3	KG	0.7
BK001-0300	Bulk Dispenser - Tall Single Bin - Stainless Steel	58	IN	12.13	17.07	5.75	LB	7.5
			CM	30.8	43.4	14.6	KG	3.4
BK002-0300	Bulk Dispenser - Short Single Bin - Stainless Steel	Referenced: 59	IN	12.13	11.13	5.75	LB	7.3
			CM	30.8	28.3	14.6	KG	2.4
BK004-0111	Bulk Dispenser - Large, Top Dispensing - Clear PETG Plastic	52, 54, 70	IN	9.00	12.69	5.96	LB	1.9
			CM	22.9	32.2	15.1	KG	0.9
BK101-0111	Bulk Dispenser - Mini Single Bin, Top Dispensing - Clear PETG Plastic	61	IN	6.00	8.13	5.22	LB	1.0
			CM	15.2	20.6	13.3	KG	0.4
BK102-0111	Bulk Dispenser - Mini Double Bin, Top Dispensing - Clear PETG Plastic	61	IN	12.30	8.13	5.22	LB	1.8
			CM	31.2	20.6	13.3	KG	0.8
BK103-0111	Bulk Dispenser - Mini Triple Bin, Top Dispensing - Clear PETG Plastic	61	IN	18.40	8.00	5.22	LB	2.5
			CM	46.7	20.3	13.3	KG	1.1
BK211-0111	Bulk Dispenser - Tall Single Bin, Top Dispensing - Clear PETG Plastic	61	IN	12.63	17.00	5.75	LB	3.2
			CM	31.1	43.2	14.6	KG	1.5
BK212-0111	Bulk Dispenser - Tall Double Bin, Top Dispensing - Clear PETG Plastic	61	IN	12.63	17.16	5.75	LB	3.2
			CM	31.1	43.6	14.5	KG	1.5
BK213-0111	Bulk Dispenser - Tall Triple Bin, Top Dispensing - Clear PETG Plastic	61	IN	18.76	17.16	5.75	LB	5.0
			CM	47.7	43.6	14.5	KG	2.3
BK214-0111	Bulk Dispenser - Tall Quad Bin, Top Dispensing - Clear PETG Plastic	61	IN	24.86	17.16	5.75	LB	6.4
			CM	63.1	43.6	14.5	KG	2.9
BK312-0300	Bulk Dispenser - Tall Double Bin - Stainless Steel	58	IN	12.18	17.07	5.75	LB	7.0
			CM	30.9	43.3	14.6	KG	3.2
BK313-0300	Bulk Dispenser - Tall Triple Bin - Stainless Steel	58	IN	18.21	17.07	5.75	LB	9.8
			CM	46.2	43.3	14.6	KG	4.4
BK314-0111	Bulk Dispenser - Tall Quad Bin - Clear PETG Plastic	60	IN	24.69	17.45	5.86	LB	6.4
			CM	62.7	44.3	14.9	KG	2.9
BK314-0300	Bulk Dispenser - Tall Quad Bin - Stainless Steel	58	IN	24.16	17.07	5.75	LB	12.7
			CM	61.4	43.3	14.6	KG	5.7
BK501-1211	Respiratory Supplies Dispenser - Clear Polycarbonate Plastic	69	IN	7.50	18.27	6.30	LB	2.7
			CM	19.1	46.4	16.0	KG	1.2
BP-007	Bouffant Cap or Shoe Cover Dispenser - Clear PETG Plastic	63	IN	11.39	11.23	5.26	LB	1.0
			CM	28.9	28.5	13.4	KG	0.5
BP-011	Bulk Dispenser - Tall Single Bin - Clear PETG Plastic	60	IN	12.50	17.75	5.86	LB	3.2
			CM	31.8	45.1	14.9	KG	1.4

Part Number	Product Name	Page	Unit	W (L)	H	D	Product Weight	
BP-012	Bulk Dispenser - Tall Double Bin - Clear PETG Plastic	60	IN	12.50	17.75	5.86	LB	3.5
			CM	31.8	45.1	14.9	KG	1.6
BP-021	Bulk Dispenser - Short Single Bin - Clear PETG Plastic	59	IN	12.50	11.50	5.86	LB	2.2
			CM	31.8	29.2	14.8	KG	1.0
BP-022	Bulk Dispenser - Short Double Bin - Clear PETG Plastic	59	IN	12.50	11.50	5.87	LB	2.4
			CM	31.8	29.2	14.9	KG	1.1
BP-023	Bulk Dispenser - Short Triple Bin - Clear PETG Plastic	59	IN	17.80	11.50	5.87	LB	3.5
			CM	45.2	29.2	14.9	KG	1.6
BP-090	Bulk Dispenser - Tall Triple Bin - Clear PETG Plastic	60	IN	18.70	17.45	5.85	LB	5.0
			CM	47.5	44.3	14.3	KG	2.2
BW100-0212	Bottle Holder - Universal - Hand Gel - Quartz Beige ABS Plastic	Not Pictured	IN	4.35	4.00	4.66	LB	0.3
			CM	11.0	10.2	11.8	KG	0.1
BWX01-0412	Disposable Wipe Bracket - Quartz Beige Powder-Coated Steel	Not Pictured	IN	3.65	3.80	5.00	LB	0.6
			CM	9.2	9.7	12.7	KG	0.3
BWX02-0412	Disposable Wipe Bracket Pole Mount - For use with the BWX01-0412 - Quartz Beige Powder-Coated Steel	Not Pictured	IN	1.75	2.55	2.67	LB	0.8
			CM	4.4	6.5	6.7	KG	0.4
CL002-0111	Task Wipe Dispenser - Small - Clear PETG Plastic	Not Pictured	IN	5.20	5.10	3.20	LB	0.3
			CM	13.2	13.0	8.1	KG	0.1
CL003-0111	Task Wipe Dispenser - Large - Clear PETG Plastic	Not Pictured	IN	5.20	15.85	3.95	LB	1.0
			CM	13.2	40.3	10.0	KG	0.5
CL006-0212	Scrub Brush Dispenser - Quartz Beige ABS Plastic	Referenced: 66	IN	5.08	9.10	5.33	LB	0.3
			CM	13.0	23.1	13.5	KG	0.2
CL007-0212	Scrub Brush Dispenser - Quartz Beige ABS Plastic	66	IN	5.45	9.10	5.45	LB	0.8
			CM	13.8	23.1	13.8	KG	0.3
CL011-0111	Personal Wipe Dispenser - Short - Clear PETG Plastic	Referenced: 67	IN	4.45	6.10	1.45	LB	0.3
			CM	11.3	15.5	3.7	KG	0.1
CL012-0111	Personal Wipe Dispenser - Short-Thick - Clear PETG Plastic	Referenced: 67	IN	4.45	6.10	2.20	LB	0.3
			CM	11.3	15.5	5.6	KG	0.1
CL021-0111	Personal Wipe Dispenser - Tall - Clear PETG Plastic	67	IN	6.20	10.35	1.45	LB	0.5
			CM	15.7	26.3	3.6	KG	0.2
CL022-0111	Personal Wipe Dispenser - Tall-Thick - Clear PETG Plastic	67	IN	6.20	10.35	2.75	LB	0.7
			CM	15.7	26.3	6.9	KG	0.3
CP-072	Eyewear Dispenser - Hinged Lid - Clear PETG Plastic	Referenced: 70	IN	9.25	3.45	6.91	LB	1.1
			CM	23.5	8.8	17.6	KG	0.5
CP-075	Eyewear Cabinet - Locking - White ABS Plastic with Clear PETG Plastic Locking Door	70	IN	13.50	20.00	4.13	LB	4.3
			CM	34.3	50.8	10.5	KG	1.9
CT030-0000	Mobile Protection System - Safety Yellow Powder-Coated Aluminum and Steel, Gray Powder-Coated Aluminum, Brushed Nickel Hardware and Polycarb Plastic Lid	20, 23	IN	26.85	55.36	16.67	LB	75.0
			CM	68.1	140.6	42.3	KG	34.0
ED-097	Infection Prevention System - Quartz Beige ABS Plastic & Clear PETG Plastic Sign Holder	25	IN	15.00	11.38	5.75	LB	1.8
			CM	38.1	28.9	14.6	KG	0.8
ED-750	Epinephrine Injector Dispenser - 5 Injector Capacity - Quartz Beige ABS Plastic with Clear PETG Plastic Door	Not Pictured	IN	8.92	11.19	2.51	LB	1.9
			CM	22.6	28.4	6.4	KG	0.8
ED-760	Epinephrine Injector Dispenser - 10 Injector Capacity - Yellow Sintra® Plastic with Clear PETG Plastic Divider	Not Pictured	IN	9.49	11.19	4.75	LB	2.4
			CM	24.1	28.4	12.0	KG	1.1
FB-021	Face Mask Dispenser - Tie Style - White Powder-Coated Steel	Not Pictured	IN	7.44	4.75	4.81	LB	0.9
			CM	18.9	12.1	12.2	KG	0.4
FB-037	Face Mask Dispenser - Earloop Style - White Powder-Coated Steel	53, 56	IN	7.56	4.25	4.13	LB	0.7
			CM	19.2	10.8	10.5	KG	0.3

Part Number	Product Name	Page	Unit	W (L)	H	D	Product Weight	
FB-040	Face Mask Dispenser - Tie Style - White Powder-Coated Steel	<i>Not Pictured</i>	IN	8.00	6.00	5.25	LB	1.3
			CM	20.3	15.2	13.3	KG	0.6
FB-063	Face Mask Dispenser - Tie Style - White Powder-Coated Steel	<i>Not Pictured</i>	IN	7.80	7.50	5.25	LB	1.4
			CM	19.8	19.1	13.3	KG	0.6
FB-064	Face Mask Dispenser - Earloop Style - White Powder-Coated Steel	56	IN	7.56	4.25	4.13	LB	0.8
			CM	19.2	10.8	10.5	KG	0.3
FB-090	Face Mask Dispenser - Face Shield Style - White Powder-Coated Steel	53, 56	IN	9.06	7.53	4.06	LB	1.2
			CM	23.0	19.1	10.3	KG	0.5
FB-091	Face Mask Dispenser - Tie Style - White Powder-Coated Steel	53, 56	IN	7.90	7.70	5.00	LB	1.2
			CM	20.1	19.6	12.7	KG	0.5
FD-005	Face Mask Dispenser - Earloop Style - Bulk - White ABS Plastic & Clear PETG Plastic	52	IN	8.66	4.98	4.38	LB	1.0
			CM	22.0	12.6	11.1	KG	0.4
FD-062	Respiratory Hygiene Station - Locking - Quartz Beige ABS Plastic & Clear PETG Plastic Lid	<i>Not Pictured</i>	IN	17.50	10.25	5.00	LB	3.2
			CM	44.5	26.0	12.7	KG	1.5
FD-068	Infection Prevention System - Quartz Beige ABS Plastic	24, 25	IN	18.50	11.63	4.50	LB	2.1
			CM	47.0	29.5	11.4	KG	0.9
FM001-0212	Face Mask Dispenser - Surgical with Dividers - Quartz Beige ABS Plastic	66	IN	26.50	12.75	10.93	LB	8.3
			CM	67.3	32.4	27.7	KG	3.8
FM002-0212	Face Mask Dispenser - Combo or Protection System - Compact - Quartz Beige ABS Plastic	9, 12, 53	IN	10.63	25.25	5.00	LB	3.3
			CM	27.0	64.1	12.7	KG	1.5
FM004-0212	Face Mask Dispenser - Surgical with Dividers and Three MP-035 Sign Holders - Quartz Beige ABS Plastic & Clear PETG Plastic	53	IN	26.50	20.69	10.62	LB	11.0
			CM	67.3	52.6	27.0	KG	5.0
FM006-0111	Face Mask Dispenser - Shield Style - Clear PETG Plastic	56	IN	11.83	7.50	4.20	LB	0.9
			CM	30.0	19.0	10.7	KG	0.4
FM013-0212	Face Mask Dispenser - Triple - Quartz Beige ABS Plastic	66	IN	8.01	13.98	5.83	LB	1.1
			CM	20.3	35.5	14.8	KG	0.5
FM014-0212	Face Mask Dispenser - Quint - Quartz Beige ABS Plastic	<i>Referenced: 66</i>	IN	8.01	23.11	5.83	LB	1.8
			CM	20.3	58.7	14.8	KG	0.8
FM100-0212	Face Mask Dispenser - Universal Boxed - Earloop - Quartz Beige ABS Plastic	53, 54	IN	8.25	4.63	5.75	LB	0.5
			CM	21.0	11.8	14.6	KG	0.2
FM200-0212	Face Mask Dispenser - Universal Boxed - Face Shield - Quartz Beige ABS Plastic	53, 54	IN	9.75	8.63	4.75	LB	1.0
			CM	24.8	21.9	12.1	KG	0.5
FM300-0212	Face Mask Dispenser - Universal Boxed - Cone - Quartz Beige ABS Plastic	53, 54	IN	6.75	7.13	5.75	LB	0.7
			CM	17.1	18.1	14.6	KG	0.3
FM401-0111	Face Mask Dispenser - 4" Deep, Earloop Style - Clear PETG Plastic	52, 54	IN	8.50	5.60	4.06	LB	0.8
			CM	21.5	14.2	10.3	KG	0.4
FM402-0111	Face Mask Dispenser - 4" Deep, Shield Style - Clear PETG Plastic	52, 54	IN	12.00	9.00	4.08	LB	1.5
			CM	30.5	22.9	10.4	KG	0.7
FP-017	Face Mask Dispenser - Bulk - Cone or Pre-Assembled Eye Shields - Clear PETG Plastic	52, 54, 66, 70	IN	6.70	9.19	6.01	LB	1.2
			CM	17.0	23.3	15.3	KG	0.5
FP-021	Face Mask Dispenser - Earloop Style - Clear PETG Plastic	56	IN	7.95	4.23	5.20	LB	0.5
			CM	20.2	10.7	13.2	KG	0.2
FP-022	Face Mask Dispenser - Earloop Style - Clear PETG Plastic	<i>Not Pictured</i>	IN	8.12	7.72	4.91	LB	0.9
			CM	20.6	19.6	12.5	KG	0.4
FP-038	Face Mask Dispenser - Earloop Style - Clear PETG Plastic	56	IN	7.70	4.32	4.27	LB	0.4
			CM	19.6	11.0	10.8	KG	0.2
FP-120	Face Mask Dispenser - Shield Style - Clear PETG Plastic	56	IN	9.20	7.50	4.20	LB	0.7
			CM	23.4	19.1	10.7	KG	0.3

Part Number	Product Name	Page	Unit	W (L)	H	D	Product Weight	
FP-121	Face Mask Dispenser - Earloop Style - Clear PETG Plastic	<i>Not Pictured</i>	IN	7.70	4.35	4.33	LB	0.5
			CM	19.6	11.0	10.9	KG	0.2
FP-122	Face Mask Dispenser - Tie Style - Clear PETG Plastic	<i>Not Pictured</i>	IN	8.08	7.60	5.58	LB	0.8
			CM	20.5	19.3	14.2	KG	0.3
FS001-0111	Wax Paper Dispenser - Clear PETG Plastic	<i>Referenced: 71</i>	IN	6.20	10.35	2.75	LB	0.7
			CM	15.7	26.3	7.0	KG	0.3
FS001-0300	Wax Paper Dispenser - Stainless Steel	71	IN	6.06	10.29	2.62	LB	1.4
			CM	15.4	26.1	6.7	KG	0.6
GB-001	Glove Box Dispenser - Single Flexible Spring - White Powder-Coated Steel	39, 43	IN	5.60	9.96	3.80	LB	1.4
			CM	14.2	25.3	9.7	KG	0.6
GB-002	Glove Box Dispenser - Double - White Powder-Coated Steel	43	IN	10.56	10.03	3.81	LB	1.6
			CM	26.8	25.5	9.7	KG	0.7
GB-003	Glove Box Dispenser - Triple - White Powder-Coated Steel	43	IN	15.81	10.03	3.81	LB	1.8
			CM	40.2	25.5	9.7	KG	0.8
GB-059	Glove Box Dispenser - Quad - White Powder-Coated Steel	43	IN	22.32	9.99	3.81	LB	2.7
			CM	56.7	25.4	9.7	KG	1.2
GB-067	Glove Box Dispenser - Double - Space Saver - White Powder-Coated Steel	<i>Referenced: 45</i>	IN	5.60	20.04	3.94	LB	2.5
			CM	14.2	50.9	10.0	KG	1.1
GB-068	Glove Box Dispenser - Triple - Space Saver - White Powder-Coated Steel	45	IN	5.50	30.04	3.94	LB	3.5
			CM	14.0	76.3	10.0	KG	1.6
GB-074	Glove Box Dispenser - Single - Large Capacity with Flexible Spring - White Powder-Coated Steel	<i>Referenced: 46</i>	IN	6.50	9.96	3.80	LB	1.6
			CM	16.5	25.3	9.7	KG	0.7
GB-144	Glove Box Dispenser - Single with Flexible Spring - Cabinet Mount - White Powder-Coated Steel	48, 76	IN	5.60	10.00	3.80	LB	1.4
			CM	14.2	25.4	9.7	KG	0.6
GC-009	Glove Dispenser - Bulk - White Sintra® Plastic	47	IN	5.00	11.25	4.36	LB	0.5
			CM	12.7	28.6	11.0	KG	0.2
GC-018	Glove Box Dispenser - Single with Flexible Spring - White Sintra® Plastic	<i>Not Pictured</i>	IN	5.80	10.06	4.07	LB	0.5
			CM	14.7	25.6	10.3	KG	0.2
GL002-0413	Glove Box Dispenser - Double with Divider - White Powder-Coated Steel	39	IN	10.60	10.03	3.81	LB	2.3
			CM	26.9	25.5	9.6	KG	1.0
GL003-0413	Glove Box Dispenser - Triple with Dividers - White Powder-Coated Steel	39, 49	IN	15.87	10.03	3.81	LB	2.3
			CM	40.3	25.5	9.7	KG	1.0
GL004-0413	Glove Box Dispenser - Quad with Dividers - White Powder-Coated Steel	39	IN	21.16	10.03	3.81	LB	2.4
			CM	53.7	26.1	9.7	KG	1.1
GL010-0223	Glove Box Dispenser - Single - Maple Fauxwood ABS Plastic	38, 73	IN	5.75	10.13	4.00	LB	0.8
			CM	14.6	25.7	10.2	KG	0.4
GL010-0233	Glove Box Dispenser - Single - Cherry Fauxwood ABS Plastic	38	IN	5.75	10.13	4.00	LB	0.8
			CM	14.6	25.7	10.2	KG	0.4
GL011-0613*	Glove Box Dispenser - Single - White Coated-Wire	42	IN	5.67	8.32	3.96	LB	0.7
			CM	14.4	21.1	10.0	KG	0.3
GL016-0111	Glove Box Dispenser - Extra Long - Single - Clear PETG Plastic	44	IN	5.45	16.10	2.95	LB	0.8
			CM	13.8	40.9	7.5	KG	0.3
GL018-0300	Glove Box Dispenser - Triple - Stainless Steel	47	IN	10.31	14.28	3.94	LB	2.7
			CM	26.2	36.3	10.00	KG	1.2
GL020-0111	Glove Box Dispenser - Double with Divider - Clear PETG Plastic	40	IN	11.38	10.13	4.00	LB	1.2
			CM	28.9	25.7	10.2	KG	0.5
GL020-0212	Glove Box Dispenser - Double with Divider - Quartz Beige ABS Plastic	40	IN	11.38	10.13	4.00	LB	1.2
			CM	28.9	25.7	10.2	KG	0.5

Part Number	Product Name	Page	Unit	W (L)	H	D	Product Weight	
GL020-0223	Glove Box Dispenser - Double with Divider - Maple Fauxwood ABS Plastic	38	IN	11.38	10.13	4.00	LB	1.2
			CM	28.9	25.7	10.2	KG	0.5
GL020-0233	Glove Box Dispenser - Double with Divider - Cherry Fauxwood ABS Plastic	38, 73	IN	11.38	10.13	4.00	LB	1.2
			CM	28.9	25.7	10.2	KG	0.5
GL022-0613*	Glove Box Dispenser - Double - White Coated-Wire	42	IN	10.97	8.32	3.96	LB	1.0
			CM	27.9	21.1	10.0	KG	0.4
GL030-0223	Glove Box Dispenser - Triple with Dividers - Maple Fauxwood ABS Plastic	38, 73, 77	IN	17.00	10.13	4.00	LB	1.4
			CM	43.2	25.7	10.2	KG	0.6
GL030-0233	Glove Box Dispenser - Triple with Dividers - Cherry Fauxwood ABS Plastic	38	IN	17.00	10.13	4.00	LB	1.4
			CM	43.2	25.7	10.2	KG	0.6
GL033-0613*	Glove Box Dispenser - Triple - White Coated-Wire	42	IN	16.32	8.32	3.96	LB	1.3
			CM	41.5	21.1	10.0	KG	0.6
GL036-0111	Glove Box Dispenser - Extra Long - Triple - Clear PETG Plastic	44	IN	15.70	16.10	2.95	LB	1.8
			CM	39.9	40.9	7.5	KG	0.8
GL040-0111	Glove Box Dispenser - Quad with Dividers - Clear PETG Plastic	40	IN	22.63	10.13	4.00	LB	1.9
			CM	57.5	25.7	10.2	KG	0.8
GL040-0212	Glove Box Dispenser - Quad with Dividers - Quartz ABS Plastic	40	IN	22.63	10.13	4.00	LB	1.9
			CM	57.5	25.7	10.2	KG	0.8
GL040-0223	Glove Box Dispenser - Quad with Dividers - Maple Fauxwood ABS Plastic	38	IN	22.63	10.13	4.00	LB	1.9
			CM	57.5	25.7	10.2	KG	0.8
GL040-0233	Glove Box Dispenser - Quad with Dividers - Cherry Fauxwood ABS Plastic	38, 73	IN	22.63	10.13	4.00	LB	1.9
			CM	57.5	25.7	10.2	KG	0.8
GL044-0613*	Glove Box Dispenser - Quad - White Coated-Wire	42	IN	21.67	8.32	3.96	LB	1.6
			CM	55.0	21.1	10.0	KG	0.7
GL100-0212	Glove Box Dispenser - Single with Flexible Springs - Quartz Beige ABS Plastic	40	IN	5.84	10.11	4.22	LB	0.7
			CM	14.8	25.7	10.7	KG	0.3
GL100-1214	Glove Box Dispenser - Single with Flexible Springs - Semi-Transparent Polycarbonate Plastic	40	IN	5.84	10.11	4.22	LB	0.7
			CM	14.8	25.7	10.7	KG	0.3
GL102-0111	Glove Box Dispenser - Single - Food Service - Narrow - Clear PETG Plastic	Referenced: 46	IN	5.08	9.10	2.95	LB	0.5
			CM	12.9	23.1	7.5	KG	0.2
GL102-0300	Glove Box Dispenser - Single - Food Service - Narrow - Stainless Steel	46, 71	IN	4.95	9.04	2.82	LB	1.2
			CM	12.6	23.0	7.2	KG	0.5
GL134-0412	Glove Box Dispenser - Single with Flexible Spring - Cart Clip-On - Quartz Beige Powder-Coated Steel	46	IN	5.66	10.00	3.83	LB	1.6
			CM	14.4	25.4	9.7	KG	0.7
GL136-0412	Glove Box Dispenser - Triple - Cart Attachment - Quartz Beige Powder-Coated Steel	46	IN	16.82	10.04	3.79	LB	1.8
			CM	42.7	25.5	9.6	KG	0.8
GL143-0111	Glove Box Dispenser - Quad - Clear PETG Plastic	47	IN	20.10	11.30	3.95	LB	2.0
			CM	51.1	28.7	10.0	KG	0.9
GL143-0212	Glove Box Dispenser - Quad - Quartz Beige ABS Plastic	Referenced: 47	IN	20.10	11.30	3.95	LB	2.1
			CM	51.1	28.7	10.0	KG	0.9
GL300-0212	Glove Box Dispenser - Triple with Dividers - Quartz Beige ABS Plastic	40	IN	17.08	10.12	4.22	LB	1.4
			CM	43.4	25.7	10.7	KG	0.6
GL300-1214	Glove Box Dispenser - Triple with Dividers - Semi-Transparent Polycarbonate Plastic	40, 48, 76	IN	17.08	10.12	4.22	LB	1.4
			CM	43.4	25.7	10.7	KG	0.6
GN001-0212	Gown Dispenser - Bulk - Quartz Beige ABS Plastic	66	IN	14.63	15.44	5.06	LB	2.7
			CM	37.1	39.2	12.8	KG	1.2
GN100-0212	Gown Dispenser - Universal Boxed Thumb Loop - Quartz Beige ABS Plastic	66	IN	7.95	9.85	4.95	LB	1.0
			CM	20.2	25.0	12.6	KG	0.5

*IMPORTED

Part Number	Product Name	Page	Unit	W (L)	H	D	Product Weight	
GP-013	Glove Box Dispenser - Single with Flexible Spring - Clear PETG Plastic	42	IN	5.70	9.85	3.95	LB	0.7
			CM	14.5	25.0	10.0	KG	0.3
GP-014	Glove Box Dispenser - Double - Clear PETG Plastic	42	IN	10.70	10.10	3.95	LB	0.9
			CM	27.2	25.7	10.0	KG	0.4
GP-015	Glove Box Dispenser - Triple - Clear PETG Plastic	42	IN	15.95	10.10	3.95	LB	1.0
			CM	40.5	25.7	10.0	KG	0.4
GP-020	Glove Box Dispenser - Single - Large Capacity with Flexible Spring - Clear PETG Plastic	Referenced: 46	IN	6.64	10.03	4.01	LB	0.9
			CM	16.9	25.5	10.2	KG	0.4
GP-061	Glove Box Dispenser - Quad - Clear PETG Plastic	42	IN	22.45	10.03	3.88	LB	1.2
			CM	57.0	25.5	9.9	KG	0.5
GP-071	Glove Box Dispenser - Single - Narrow - Clear PETG Plastic	Referenced: 46	IN	5.70	9.85	2.95	LB	0.7
			CM	14.5	25.0	7.5	KG	0.3
GP-072	Glove Box Dispenser - Double - Narrow - Clear PETG Plastic	Referenced: 46	IN	10.70	10.10	2.95	LB	0.8
			CM	27.2	25.7	7.5	KG	0.3
GP-073	Glove Box Dispenser - Triple - Narrow - Clear PETG Plastic	46	IN	15.95	10.10	2.95	LB	0.9
			CM	40.5	25.7	7.5	KG	0.4
GP-106	Glove Box Dispenser - Double - Space Saver - Clear PETG Plastic	Referenced: 45	IN	5.70	20.10	4.08	LB	1.4
			CM	14.5	51.1	10.4	KG	0.6
GP-107	Glove Box Dispenser - Triple - Space Saver - Clear PETG Plastic	45	IN	5.50	30.11	3.94	LB	2.0
			CM	14.0	76.5	10.0	KG	0.9
GP-310	Glove Box Dispenser - Single - Clear PETG Plastic	44	IN	10.45	4.85	3.70	LB	0.7
			CM	26.5	12.3	9.4	KG	0.3
GP-320	Glove Box Dispenser - Double - Clear PETG Plastic	44	IN	10.45	9.60	3.70	LB	1.2
			CM	26.5	24.4	9.4	KG	0.5
GP-330	Glove Box Dispenser - Triple - Clear PETG Plastic	44	IN	10.45	14.35	3.70	LB	1.7
			CM	26.5	36.4	9.4	KG	0.7
GP-340	Glove Box Dispenser - Quad - Clear PETG Plastic	44	IN	10.45	19.10	3.70	LB	2.3
			CM	26.5	48.5	9.4	KG	1.0
GS-004	Glove Box Dispenser - Single with Flexible Spring - Stainless Steel	39, 43	IN	5.60	9.96	3.80	LB	1.4
			CM	14.2	25.3	9.7	KG	0.6
GS-005	Glove Box Dispenser - Double - Stainless Steel	43	IN	10.57	10.04	3.82	LB	1.4
			CM	26.8	25.5	9.7	KG	0.6
GS-006	Glove Box Dispenser - Triple - Stainless Steel	43	IN	15.82	10.04	3.78	LB	1.8
			CM	40.2	25.5	9.6	KG	0.8
GS-060	Glove Box Dispenser - Quad - Stainless Steel	43	IN	22.32	10.04	3.78	LB	2.4
			CM	56.7	25.5	9.6	KG	1.1
GS-073	Glove Box Dispenser - Single - Large Capacity with Flexible Spring - Stainless Steel	46	IN	6.50	9.96	3.80	LB	1.5
			CM	16.5	25.3	9.7	KG	0.7
GS-108	Glove Box Dispenser - Double - Space Saver - Stainless Steel	Referenced: 45	IN	5.60	20.03	3.94	LB	2.4
			CM	14.2	50.9	10.0	KG	1.1
GS-109	Glove Box Dispenser - Triple - Space Saver - Stainless Steel	45	IN	5.50	30.04	3.94	LB	3.6
			CM	14.0	76.3	10.0	KG	1.6
GS-122	Glove Box Dispenser - Double with Divider - Stainless Steel	39	IN	10.59	10.03	3.81	LB	1.8
			CM	26.9	25.5	9.7	KG	0.8
GS-123	Glove Box Dispenser - Triple with Dividers - Stainless Steel	39	IN	15.87	10.03	3.81	LB	2.3
			CM	40.3	25.5	9.7	KG	1.0
GS-124	Glove Box Dispenser - Quad with Dividers - Stainless Steel	39	IN	21.16	10.03	3.81	LB	2.4
			CM	53.7	25.5	9.7	KG	1.1

Part Number	Product Name	Page	Unit	W (L)	H	D	Product Weight	
HH004-0412	Hanger - Glass and Laminate - Quartz Beige Powder-Coated Steel	11	IN	10.00	4.62	0.56	LB	0.5
			CM	25.4	11.7	1.4	KG	0.2
HP-010	Hairnet Dispenser - Bulk - Clear PETG Plastic	71	IN	4.64	7.88	3.68	LB	0.7
			CM	11.8	20.0	9.3	KG	0.3
KS010-0412	Floor Stand - All Steel - Quartz Beige Powder-Coated Steel	24, 25	IN	18.00	36.06	18.00	LB	16.0
			CM	45.7	91.6	45.7	KG	7.3
KS101-0029*	Hand Sanitizer Floor Stand - Bay Gray Steel Back Plate, Column, and Base	34	IN	18.00	54.73	18.00	LB	16.0
			CM	45.7	139.0	45.7	KG	7.3
KS102-0029*	Hand Sanitizer Floor Stand - Bay Gray Steel Back Plate, Column, and Base - Quartz Beige ABS Plastic Drip Tray	Not Pictured	IN	18.00	54.73	18.00	LB	16.3
			CM	45.7	139.0	45.7	KG	7.4
KS122-0529	Infection Prevention Station - Bay Gray Powder-Coated Aluminum	Not Pictured	IN	7.21	15.11	4.29	LB	2.0
			CM	18.3	38.4	10.9	KG	0.9
KS123-0529	Infection Prevention Station Accessory for Hand Sanitizer Floor Stand - Bay Gray Powder-Coated Aluminum with Semi-Permanent VHB Tape	Not Pictured	IN	7.21	15.11	4.29	LB	2.0
			CM	18.3	38.4	10.9	KG	0.9
KS201-0029*	Floor Stand - Bay Gray Powder-Coated Steel Mounting Plate, Column, and Base	25	IN	18.00	36.73	18.00	LB	15.3
			CM	45.7	93.3	45.7	KG	6.9
LB100-0212	Safety Eyewear Dispenser - Divided - Quartz Beige ABS Plastic	70	IN	20.75	15.75	7.13	LB	8.3
			CM	52.7	40.0	18.1	KG	3.8
LD-007	Protection System - Quartz Beige ABS Plastic (Aluminum Version PS021-0512)	9, 12	IN	16.63	25.13	4.62	LB	4.5
			CM	42.2	63.8	11.7	KG	2.0
LD-037	Protection System - Quartz Beige ABS Plastic (Aluminum Version PS022-0512)	9, 12	IN	23.50	20.80	4.75	LB	5.6
			CM	59.7	52.8	12.1	KG	2.5
LD-064	Protection System - 4" Deep - Quartz Beige ABS Plastic	12, 15	IN	16.77	25.63	4.00	LB	3.7
			CM	42.5	65.1	10.2	KG	1.7
LD-070	Protection System - Quartz Beige ABS Plastic	9, 12	IN	20.05	25.25	4.75	LB	4.6
			CM	50.9	64.1	12.1	KG	2.1
LP-004	Protection System - Surgical - Quartz Beige ABS Plastic & Clear PETG Plastic (Aluminum Version PS023-0512)	Not Pictured	IN	22.15	19.68	4.88	LB	4.8
			CM	56.3	50.0	12.4	KG	2.2
MB-450	Hanger - Metal Bracketed Door - Quartz Beige Powder-Coated Steel	11	IN	26.14	29.49	2.92	LB	2.5
			CM	66.4	74.9	7.4	KG	1.1
MB-500	Hanger - Glass - Quartz Beige Powder-Coated Steel with Semi-Permanent VHB Tape	Not Pictured	IN	22.00	4.62	0.56	LB	1.0
			CM	55.9	11.7	1.4	KG	0.4
MB-510	Hanger - Wall - Quartz Beige Powder-Coated Steel	17	IN	5.50	2.62	0.56	LB	0.2
			CM	14.0	6.7	1.4	KG	0.1
MB-600	Hanger - Door - Standard - Quartz Beige Powder-Coated Steel	10	IN	5.50	12.13	3.03	LB	1.1
			CM	14.0	30.8	7.6	KG	0.5
MB-601	Hanger - Door - Long - Quartz Beige Powder-Coated Steel	Referenced: 10	IN	5.50	19.00	3.03	LB	1.4
			CM	14.0	48.3	7.6	KG	0.6
MD-100	Dental Organizer - Quartz Beige ABS Plastic & Clear PETG Plastic	71	IN	17.61	23.50	5.08	LB	4.4
			CM	44.7	59.7	12.9	KG	2.0
MP-015	Caddy Dispenser - Clip-On - Clear PETG Plastic	Not Pictured	IN	6.20	7.33	6.65	LB	0.9
			CM	15.7	18.6	16.9	KG	0.4
MP-035	Sign Holder for FM001-0213 - Clear PETG Plastic	53	IN	8.50	11.90	0.38	LB	0.9
			CM	21.6	28.4	1.0	KG	0.4
MP-047	Sign Holder - Clip-On - Clear PETG Plastic	11, 16, 19, 20, 80, 81	IN	8.50	11.16	0.55	LB	0.8
			CM	21.6	28.3	1.3	KG	0.3
MP-070	Sign Holder - Vertical - Clear PETG Plastic	70	IN	8.63	13.36	0.34	LB	1.1
			CM	21.9	35.0	0.9	KG	0.5

*IMPORTED

Part Number	Product Name	Page	Unit	W (L)	H	D	Product Weight	
MP-075	Sign Holder - Horizontal - Clear PETG Plastic	25, 70	IN	11.00	10.90	0.34	LB	1.2
			CM	28.6	28.7	0.9	KG	0.5
MP-085	Caddy Dispenser - Clip-On - Clear PETG Plastic	Not Pictured	IN	4.80	8.10	5.05	LB	0.9
			CM	12.2	20.6	12.8	KG	0.4
MW-001*	Biohazard Bag Holder - 1 Gallon - White Coated-Wire	69	IN	9.50	12.88	6.25	LB	1.7
			CM	24.1	32.7	15.9	KG	0.7
MW-003*	Biohazard Bag Holder - 3 Gallon - White Coated-Wire	69	IN	11.75	15.25	8.00	LB	2.1
			CM	29.8	38.7	20.3	KG	1.0
MW-005*	Biohazard Bag Holder - 5 Gallon - White Coated-Wire	69	IN	13.50	19.50	8.50	LB	2.7
			CM	34.3	49.5	21.6	KG	1.2
NC001-0512	Bedpan/Urinal Dispenser - Quartz Beige Powder-Coated Aluminum	67, 77	IN	12.33	12.00	4.66	LB	1.9
			CM	31.3	30.5	11.8	KG	0.8
NC010-0111	CPR Dispenser - Clear PETG Plastic	69	IN	5.20	2.85	2.50	LB	0.2
			CM	13.2	7.2	6.4	KG	0.1
NC012-0412	Bedpan/Urinal Dispenser - Quartz Beige Powder-Coated Steel	67	IN	12.33	12.00	4.14	LB	3.6
			CM	31.3	30.5	10.5	KG	1.6
PD100-0212	Protection Dispenser - Universal Boxed - Shoe Cover/Cap/Other - Standard - Quartz Beige ABS Plastic	64, 65	IN	12.25	10.13	7.63	LB	1.8
			CM	31.1	25.7	19.4	KG	0.8
PD200-0212	Protection Dispenser - Universal Boxed - Shoe Cover/Cap/Other - Large - Quartz Beige ABS Plastic	64, 65	IN	12.50	10.13	9.88	LB	1.9
			CM	31.8	25.7	25.1	KG	0.8
PD300-0212	Protection Dispenser - Universal Boxed - Shoe Cover/Cap/Other - Wide - Quartz Beige ABS Plastic	64, 65	IN	13.70	5.73	6.95	LB	1.0
			CM	34.8	14.6	17.7	KG	0.5
PS001-0212	Protection System - With Door - Quartz Beige ABS Plastic	9, 13	IN	22.75	20.63	4.86	LB	5.2
			CM	57.7	52.4	12.3	KG	2.3
PS004-0111	Protection System - Glove & Bag - Clear PETG Plastic	Referenced: 47	IN	10.10	20.40	3.95	LB	1.2
			CM	25.7	51.8	10.0	KG	0.5
PS004-0212	Protection System - Glove & Bag - Quartz Beige ABS Plastic	47, 68	IN	10.10	20.40	3.95	LB	1.3
			CM	25.7	51.8	10.0	KG	0.6
PS012-0512	Protection System - Quad Glove - Quartz Beige Powder-Coated Aluminum	Not Pictured	IN	22.75	25.63	4.58	LB	7.3
			CM	57.8	65.1	11.6	KG	3.3
PS014-0212	Protection System - Gloveless - Quartz Beige ABS Plastic	9, 13	IN	23.38	14.98	4.75	LB	4.2
			CM	59.4	38.0	12.1	KG	1.9
PS015-0212	Protection System - Double Gown - Quartz Beige ABS Plastic	9, 13	IN	25.07	30.75	4.75	LB	9.4
			CM	63.3	78.1	12.1	KG	4.3
PS015-0512	Protection System - Double Gown - Quartz Beige Powder-Coated Aluminum	Referenced: 9	IN	25.05	30.75	4.65	LB	11.0
			CM	63.6	78.1	11.8	KG	5.0
PS016-0111	Protection System - Clear PETG Plastic	8	IN	23.38	26.63	4.75	LB	3.1
			CM	59.4	67.6	12.1	KG	1.4
PS016-0212	Protection System - Quartz Beige ABS Plastic	8, 13	IN	23.38	26.63	4.75	LB	7.7
			CM	59.4	67.6	12.1	KG	3.5
PS016-0223	Protection System - Maple Fauxwood ABS Plastic	8	IN	23.38	26.63	4.75	LB	7.8
			CM	59.4	67.6	12.1	KG	3.5
PS016-0233	Protection System - Cherry Fauxwood ABS Plastic	8	IN	23.38	26.63	4.75	LB	7.8
			CM	59.4	67.6	12.1	KG	3.5
PS016-0300	Protection System - Stainless Steel	8	IN	22.75	25.63	4.52	LB	13.2
			CM	57.8	65.1	11.5	KG	7.3
PS016-0512	Protection System - Quartz Beige Powder-Coated Aluminum	8	IN	22.75	25.63	4.58	LB	7.6
			CM	57.8	65.1	11.6	KG	3.4

*IMPORTED

Part Number	Product Name	Page	Unit	W (L)	H	D	Product Weight
PS017-0212	Protection System - Surgical - Clear PETG Plastic & Quartz Beige ABS Plastic	63	IN	25.00	30.19	6.75	LB 11.7
			CM	63.5	76.7	17.1	KG 5.3
PS021-0512	Protection System - Quartz Beige Powder-Coated Aluminum (ABS Version LD-007)	Referenced: 12	IN	16.48	25.18	4.35	LB 5.9
			CM	41.8	63.9	11.0	KG 2.7
PS022-0512	Protection System - Quartz Beige Powder-Coated Aluminum (ABS Version LD-037)	Referenced: 12	IN	22.75	20.23	4.63	LB 6.1
			CM	57.8	51.4	11.7	KG 2.7
PS023-0212	Protection System - Surgical - Quartz Beige ABS Plastic	9, 13, 63	IN	22.30	16.68	5.10	LB 4.6
			CM	56.6	42.3	13.0	KG 2.1
PS023-0512	Protection System - Surgical - Quartz Beige Powder-Coated Aluminum	Referenced: 13	IN	22.10	16.53	4.76	LB 6.6
			CM	56.1	42.0	12.1	KG 3.0
PS026-0212	Surgical Apparel Organizer - Clear PETG Plastic and Quartz Beige ABS Plastic	62	IN	12.66	29.75	6.40	LB 6.2
			CM	32.1	75.5	16.2	KG 2.8
PS412-0212	Protection System - Quad Glove - 4" Deep - Quartz Beige ABS Plastic	15	IN	23.38	26.63	4.00	LB 7.1
			CM	59.3	67.6	10.2	KG 3.2
PS412-0512	Protection System - Quad Glove - 4" Deep - Quartz Beige Powder-Coated Aluminum	Referenced: 13	IN	22.75	25.63	4.00	LB 7.2
			CM	57.8	65.1	10.2	KG 3.3
PS415-0212	Protection System - Double Gown - 4" Deep - Quartz Beige ABS Plastic	15	IN	25.11	30.75	4.00	LB 7.2
			CM	63.8	78.1	10.2	KG 3.2
PS415-0512	Protection System - Double Gown - 4" Deep - Quartz Beige Powder-Coated Aluminum	Referenced: 13	IN	25.05	30.69	4.00	LB 9.8
			CM	63.6	78.0	10.2	KG 4.4
PS426-0212	Protection System - Gloveless - 4" Deep - Quartz Beige ABS Plastic	15	IN	15.00	19.78	4.00	LB 3.0
			CM	38.1	50.2	10.2	KG 1.4
RE101-0012	Semi-Recessed Protection System - Standard - Quartz Beige Powder-Coated Steel	19, 76, 79	IN	24.40	27.65	4.77	LB 22.4
			CM	61.9	70.2	12.1	KG 10.1
RE103-0012	Semi-Recessed Protection System - Solid Door - Quartz Beige Powder-Coated Steel	80	IN	24.40	27.65	4.77	LB 25.1
			CM	61.9	70.2	12.1	KG 11.4
RE201-0012	Semi-Recessed Protection System - Double Gown - Quartz Beige Powder-Coated Steel	19, 80, 81	IN	27.30	33.15	4.77	LB 30.2
			CM	69.3	84.2	12.1	KG 13.7
RE202-0012	Semi-Recessed Protection System - Reusable Gown - Quartz Beige Powder-Coated Steel	19, 81	IN	27.30	33.15	4.77	LB 30.2
			CM	69.3	84.2	12.1	KG 13.7
RE301-0012	Semi-Recessed Glove Box Dispenser - Triple - Quartz Beige Powder-Coated Steel	48, 82	IN	12.34	18.83	4.77	LB 9.4
			CM	31.3	47.8	12.1	KG 4.2
RE302-0012	Semi-Recessed Face Mask & Tissue Dispenser - Quartz Beige Powder-Coated Steel	83	IN	12.34	18.83	4.77	LB 9.4
			CM	31.3	47.8	12.1	KG 4.2
RE304-0012	Semi-Recessed Hand Sanitizer Dispenser - Quartz Beige Powder-Coated Steel	35, 83	IN	12.35	18.85	4.22	LB 7.4
			CM	31.4	47.9	10.7	KG 3.4
RE401-0012	Semi-Recessed Face Mask & Glove Dispenser - Quartz Beige Powder-Coated Steel	48, 83	IN	12.34	24.48	4.77	LB 11.8
			CM	31.3	62.2	12.1	KG 5.3
RE404-0012	Semi-Recessed Glove Box Dispenser - Quad - Quartz Beige Powder-Coated Steel	48, 82	IN	12.34	24.48	4.77	LB 11.8
			CM	31.3	62.2	12.2	KG 5.3
RE501-0012	Semi-Recessed Protection System - Space Saver - Quartz Beige Powder-Coated Steel	81	IN	18.77	34.66	4.77	LB 24.9
			CM	47.7	88.0	12.1	KG 11.3
RE502-0012	Semi-Recessed Protection System - Space Saver - Quartz Beige Powder-Coated Steel	81	IN	18.77	34.66	4.77	LB 24.9
			CM	47.7	88.0	12.1	KG 11.3
RG-006	Quick Reference Card for Transmission Based Precautions - Horizontal - PVC Plastic	6	IN	3.38	2.13	0.06	LB 0.0
			CM	8.6	5.4	0.2	KG 0.0
RG-008	Quick Reference Card for Transmission Based Precautions - Vertical - PVC Plastic	Referenced: 6	IN	2.13	3.38	0.06	LB 0.0
			CM	5.4	8.6	0.2	KG 0.0

Part Number	Product Name	Page	Unit	W (L)	H	D	Product Weight
RS001-0212	Respiratory Hygiene Station - Quartz Beige ABS Plastic	25	IN	17.90	10.50	4.45	LB 2.1
			CM	45.5	26.7	11.3	KG 1.0
SN003-0212	Sign Holder for KS101-0029 & KS102-0029 Floor Stands - Quartz Beige ABS Plastic	Not Pictured	IN	6.00	10.00	0.38	LB 0.5
			CM	15.2	25.4	1.0	KG 0.2
SN304-0713	Sign - Hand Sanitizer Station - White Sintra® Plastic	35, 83	IN	6.30	6.00	3.71	LB 0.1
			CM	16.0	15.2	9.4	KG 0.05
SP-003	Shoe Cover Dispenser - Clear PETG Plastic	63	IN	10.51	10.35	6.98	LB 1.1
			CM	26.7	26.3	17.7	KG 0.5
SS001-0212	Safety Station Dispenser - Quartz Beige ABS Plastic	Not Pictured	IN	17.90	10.85	5.37	LB 2.3
			CM	45.5	27.6	13.6	KG 1.0
TB-003	Towel Dispenser - White Powder-Coated Steel	71	IN	11.25	15.25	3.75	LB 3.9
			CM	28.6	38.7	9.5	KG 1.7



Ask your distributor for BOWMAN products.

BOWMAN Dispensers is a specialized design and development business creating personal protective equipment (PPE) dispensing solutions. Once a healthcare dominated industry, PPE dispensing devices have expanded in application to most commercial markets such as industrial, food service, education and beyond. We are at the forefront of innovative dispenser design across all industries.

Since 1988, with customer collaboration, BOWMAN now offers over 200 unique items in our product line. As a privately held company, our owners are involved in the business every day. BOWMAN is proud to serve as your industry advocate, partnering with you to create safe, organized and efficient work environments.

easy

ORDERING

Ask your distributor for us by name.
Accept no imitations.
There's only one genuine BOWMAN.

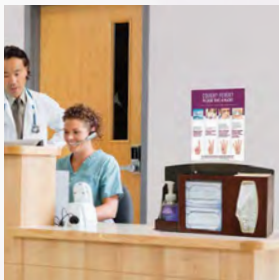

order online:

Check out conveniently from
your phone, tablet or computer:

BowmanDispensers.com



order through your regular distributor:

Find a list of our distributors online:

**BowmanDispensers.com/
About-Us/Distributors**



order over the phone:

Give us a call with questions
or to place an order:

**toll free: 800.962.4660
fax: 360.435.5277**



PATENT PENDING